

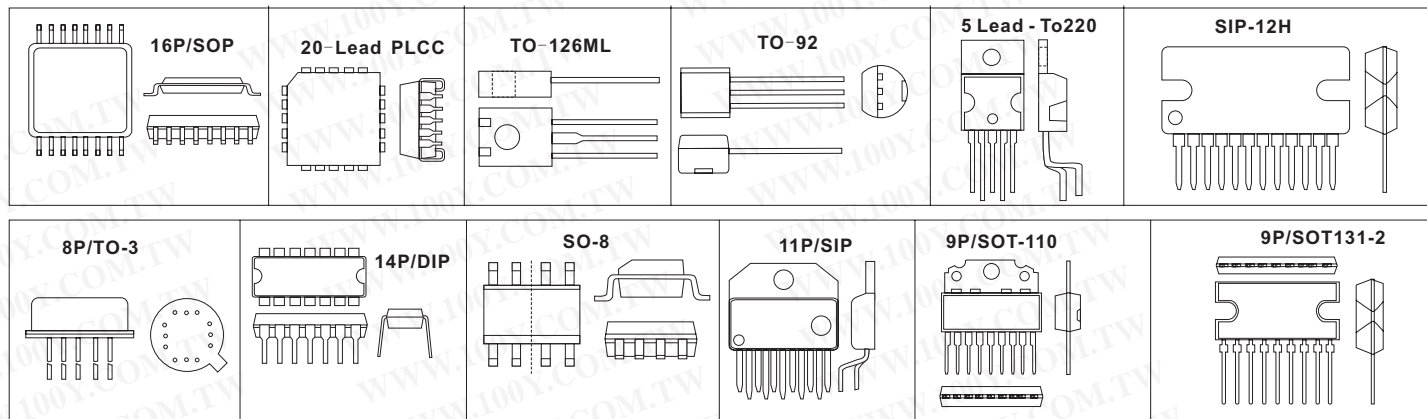

Audio Amp. IC 功率放大IC

详细产品规格 - 请点击 cn.100y.com.tw



100Y 编号	厂商编号	制造厂商	说明	Pins/Package
43069	AD8309ARU-REEL	ADI	5 MHz—500 MHz 100 dB Demodulating Logarithmic Amplifier with Limiter Output	16P/SOP
43067	AD831AP	ADI	Low Distortion Mixer	PLCC-20
41247	EL4331C	Elantec	TRIPLE 2:1 MUX-AMP AV=1	16L/SOIC
41248	EL4332CS	Elantec	MUX-AMP AV=2	16L/SOIC
17478	HA-5104/883	Intersil	Low Noise, High Performance, Quad Operational Amplifier	14P/DIP
17479	HI1-506/833	Intersil	Analog Multiplexer, Single 16-Channel, 883 Compliant	28P/DIP
22614	HSC2682	HSMC	NPN EPITAXIAL PLANAR TRANSISTOR	3P/TO-126ML
22643	KSA954Y	SAMSUNG	Audio Frequency Amplifier	3P/TO-92
22644	KSD471AC-Y	SAMSUNG	Audio Frequency Power Amplifier	3P/TO-92
39208	L165	ST(SGS)	13 Amp Power Operational Amplifier	TO-220/5P
45747	LA4635A	SANYODENKI	SANYO_SIP-12H	SIP-12H
46523	LA4636	SANYO	For General Audio Use 11 W 2-Channel BTL AF Power Amplifier	3049B-SIP12H
16226	LH0021CK	N.S	1.0 Amp Power Operational Amplifier	8P/TO-3
1234	LM1877N-9	N.S	Dual Audio Power Amplifier	14P/DIP
34741	LM2876T	N.S	Overture? Audio Power Amplifier Series High-Performance 40W Audio Power Amplifier w/Mute	11-lead TO-220
6657	LM380N	N.S	2-watt audio power amp.	14P/DIP
34437	LM386M-1	N.S	Low Voltage Audio Power Amplifier	8P/SOP
39067	LM386MMX-1	N.S	Low Voltage Audio Power Amplifier	8P/SOIC
7169	LM386MX-1	N.S	Low Voltage Audio Power Amplifier	8P/SOIC
1181	LM386N-1	N.S	Low Voltage Audio Power Amplifier	8P/DIP
39072	LM386N-3	N.S	Low Voltage Audio Power Amplifier	8P/SOIC
17655	LM3875T	N.S	High-Performance 56W Audio Power Amplifier	TO-220
34438	LM3876T	N.S	High-Performance 56W Audio Power Amplifier	11P/SIP
6553	LM388N-1	N.S	1.5 Watt audio power amplifier	14P/DIP
36609	LM4766T	N.S	Audio Power Amplifier Series Dual 40W Audio Power Amplifier with Mute	15P/TO-220
40441	LM4850MT	N.S	Mono 1.5 W / Stereo 300 mW Power Amplifier	14P/TSSOP
31998	LM4890MM	N.S	1 Watt Audio Power Amplifier	MSOP-8
31995	LM4892MM	N.S	1 Watt Audio Power Amplifier with Headphone Sense	MSOP-8
40797	LMC660CN	N.S	CMOS Quad Operational Amplifier	DIP/14P
17656	LMC662EN	N.S	CMOS Dual Operational Amplifier	8P/DIP
42432	MAX4411ETP-T	MAXIM	80mW, Fixed-Gain, Direct Drive, Stereo Headphone Amplifier with Shutdown	20 Thin QFN
19333	MC34118P	MOTOROLA	功率放大 IC	DIP
6874	MC34119P	MOTOROLA	Low power audio amplifier	8P/DIP
19335	MC3486DR	T.I.	功率放大 IC	16P/SOP
19334	MC3486N	T.I.	功率放大 IC-Pb Free	16P/DIP
33436	OP27GZ	ADI	Low-Noise, Precision Low-Noise, Precision Low-Noise, Precision Operational Amplifier	CERDIP 8-Lead
33455	OP37GS	ADI	Low Noise, Precision, High Speed Operational Amplifier	Plastic 8-Lead
41254	PA243MB	Elantec	POWER AMPLIFIER	8-MSOP
34427	PGA204AP	BB	Programmable Gain INSTRUMENTATION AMPLIFIER	16-Pin Plastic DIP
34429	PGA204AU	BB	Programmable Gain INSTRUMENTATION AMPLIFIER	SOL-16 Surface-Mount
34430	PGA205AP	BB	Programmable Gain INSTRUMENTATION AMPLIFIER	16-Pin Plastic DIP
34431	PGA205AU	BB	Programmable Gain INSTRUMENTATION AMPLIFIER	SOL-16 Surface Mount
41253	SE2520L		POWER AMPLIFIER	6P/LPCC
30622	TDA1308	PHILIPS	Class AB stereo headphone driver	SOP-8
11415	TDA1517/N3	PHILIPS	Stereo Power Amp.	9P/SOT-110
41886	TDA1517/N3/S5	PHILIPS	plastic single in-line medium power package with fin; 9 leads	SOT352-1
41883	TDA1517P	PHILIPS	plastic heat-dissipating dual in-line package; 18 leads	SOT398-1
18464	TDA1548T	PHILIPS	Bitstream continuous calibration filter-DAC with headphone driver and DSP	28P/SOP
7729	TDA2030AV	ST(SGS)	18W Hi-Fi AMPLIFIER AND 35W DRIVER	5P/TO-220
19365	TDA2040V	ST(SGS)	20W Hi-Fi AUDIO POWER AMPLIFIER	3P/PENTAWATT
19366	TDA7052A/N2	PHILIPS	功率放大 IC	DIP
11412	TDA7231A	ST(SGS)	AUDIO AMPLIFIER	8P/DIP
18965	TDA8351	PHILIPS	DC-coupled vertical deflection circuit	9P/SOT131-2



服务专线: 台湾: 886-3-5753170

传 真: 台湾: 886-3-5753172

E-mail: 台湾: sale@100y.com.tw

深圳: 86-755-83298787

深圳: 86-755-83640655

深圳: 100y@163.com

上海: 86-21-34970699

上海: 86-21-64605107

上海: 100y-1@163.com



Audio Pre-Amplifiers

详细产品规格 - 请点击 cn.100y.com.tw

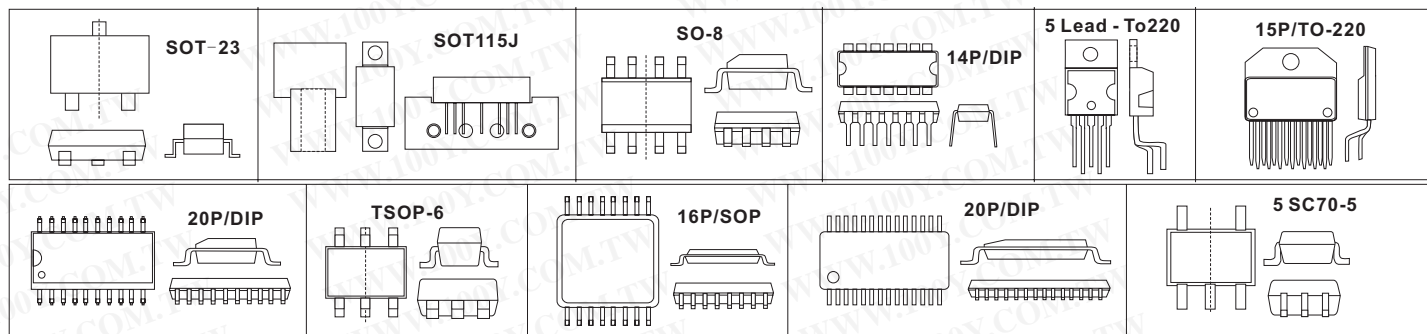

100Y 编号	厂商编号	制造厂商	说明	Pins/Package
49317	2SA812	NEC	PNP SILICON EPITAXIAL TRANSISTOR MINI MOLD	3P/SOT-23
44541	AD626AN	ADI	放大器 IC	DIP-8
41832	BGD714	PHILIPS	CATV amplifier module	SOT115J
41840	BGD814	PHILIPS	CATV amplifier module	SOT115J
41847	BGY66B	PHILIPS	CATV amplifier module	SOT115J
41856	BGY68	PHILIPS	75 MHz, 30 dB gain reverse amplifier (无铅)	SOT115J
41863	BGY685A/04	PHILIPS	CATV amplifier module (无铅)	SOT115J
41865	BGY787	PHILIPS	CATV amplifier module (无铅)	
41867	CGY887A	PHILIPS	860 MHz 25.5dB gain push-pull amplifier (无铅)	SOT115J
33001	DRV134PA	BB	AUDIO BALANCED LINE DRIVERS	8-Pin DIP
41251	EL4452CS	Elangtec	VIDEBAND VARIABLE-GAIN AMPLIFIER	SO-14
49267	HFA1112IB	Intersil	放大器 IC	8P/SOIC
44658	HFA1113IB	Intersil	放大器 IC	8P/SOIC
9986	LM1875T	N.S	20W Power Audio Amp.	5P/TO-220
18054	LM1876T	N.S	Audio Power Amplifier Series Dual 20W Audio Power Amplifier with Mute and Standby Modes	15P/TO-220
34660	LM1972N	N.S	Pot 2-Channel 78dB Audio Attenuator with Mute	20P/DIP
40615	LM2664M6	N.S	Switched Capacitor Voltage Converter	SOT23-6(MA06A)
38509	LM387AN	N.S	Low noise dual pre-amp	8P/DIP
6552	LM387N	N.S	Low noise dual pre-amp.	8P/DIP
40396	LM4835MT	N.S	Stereo 2W Audio Power Amplifiers	TSSOP/28P
35178	LM4860M	N.S	Series 1W Audio Power Amplifier with Shutdown Mode	SOP/16P
35212	LM4861M	N.S	1.1W Audio Power Amplifier with Shutdown Mode	SOP/8P
35969	LM4863N	N.S	Dual 2.2W Audio Amplifier Plus Stereo Headphone	DIP/16P
37020	LM4880M	N.S	Dual 250 mW Audio Power Amplifier with Shutdown Mode	SOP/8P
42766	LM4881M	N.S	Dual 200 mW Headphone Amplifier with Shutdown Mode	SOP/8P
40529	LM4990MM	N.S	2 Watt Audio Power Amplifier with Selectable Shutdown Logic Level	8P/MSOP
37022	LM6172IM	N.S	Dual High Speed, Low Power, Low Distortion, Voltage Feedback Amplifiers	SOP-8
37023	LM6172IN	N.S	Dual High Speed, Low Power, Low Distortion, Voltage Feedback Amplifiers	DIP/8P
37024	LM6181N	N.S	100 mA, 100 MHz Current Feedback Amplifier	DIP/8P
42277	MAX2641EUT-T	MAXIM	400MHz to 2500MHz SiGe Ultra-Low-Noise Amplifiers	6 SOT23-6
42376	MAX4205ESA	MAXIM	Ultra-High-Speed, Low-Noise, Low-Power, SOT23 Open-Loop Buffers	8 SO
42423	MAX4227ESA	MAXIM	1GHz, Low-Power, SOT23, Current-Feedback Amplifiers with Shutdown	8 SO
42449	MAX4550CAI+T	MAXIM	Serially Controlled, Dual 4x2, Clickless Audio/Video Analog Crosspoint Switches	28 SSOP
42466	MAX497CSE	MAXIM	375MHz Quad Closed-Loop Video Buffers, AV= +1 and +2	16 Narrow SO
42570	MAX9502GEXK+.pdf	MAXIM	.5V Video Amplifier with Reconstruction Filter	5 SC70-5
42582	MAX9502GEXK+T	MAXIM	2.5V Video Amplifier with Reconstruction Filter	5 SC70-5
42402	NPC2820FCTIG		2.65W Mono Class D Audio Amplifier	9-PIN FLIP-CHZP CSP
49920	SAA7210P	PHILIPS	Decoder for compact disc digital audio system	
34108	SSM2018TP	ADI	Trimless Voltage Controlled Amplifiers	16P/DIP
23704	TA31056F	TOSHIBA	Speech Speaker Amplifier	8P/SOIC
22843	TBA820M	ST(SGS)	1.2W AUDIO AMPLIFIER	8P/DIP
33765	TDA1554QN2	PHILIPS	4 x 11 W single-ended or 2 x 22 W power amplifier	SIL17
33761	TDA1558Q	PHILIPS	2 x 22 W or 4 x 11 W single-ended car radio power amplifier	SIL17
33758	TDA1905	ST(SGS)	5W AUDIO AMPLIFIER WITH MUTING	Powerdip 16
33756	TDA2002V	Fairchild	8 WATT AUDIO POWER AMPLIFIERS	5Pin Pent
33753	TDA2003V	ST(SGS)	10W CAR RADIO AUDIO AMPLIFIER	PENTAWATT
33752	TDA2004A	ST(SGS)	10 + 10W STEREO AMPLIFIER FOR CAR RADIO	MULTIWATT11
33262	TDA2005M	ST(SGS)	20W BRIDGE AMPLIFIER FOR CAR RADIO	MULTIWATT11
33715	TDA2006V	ST(SGS)	12W AUDIO AMPLIFIER	PENTAWATT
33263	TDA2030H	ST(SGS)	14W Hi-Fi AUDIO AMPLIFIER	TO-220
39555	TDA2030V	ST(SGS)	14W Hi-Fi AUDIO AMPLIFIER	TO-220
41381	TDA2050	ST(SGS)	a monolithic integrated circuit in	TO-220
33265	TDA2052	ST(SGS)	60W Hi-Fi AUDIO POWER AMPLIFIER WITH MUTE / STAND-BY	Heptawatt
33712	TDA2611A	PHILIPS	5 W audio power amplifier	SIL9
22844	TDA4950	T.I.	TV EAST/WEST CORRECTION CIRCUIT	8P/DIP
33710	TDA7050T	PHILIPS	Low voltage mono/stereo power amplifier	8P/SOIC



服务专线: 台湾: 886-3-5753170

传 真: 台湾: 886-3-5753172

E-mail: 台湾: sale@100y.com.tw

深圳: 86-755-83298787

深圳: 86-755-83640655

深圳: 100y@163.com

上海: 86-21-34970699

上海: 86-21-64605107

上海: 100y-1@163.com

放大器IC

Audio Pre-Amplifiers

详细产品规格 - 请点击 cn.100y.com.tw

100Y 编号	厂商编号	制造厂商	说明	Pins/Package
33708	TDA7052	PHILIPS	1 W BTL mono audio amplifier	DIL8
33704	TDA7263M	ST(SGS)	12 +12W STEREO AMPLIFIER WITH MUTING	Multiwatt11
33701	TDA7294V	ST(SGS)	100V - 100W DMOS AUDIO AMPLIFIER WITH MUTE/ST-BY	Multiwatt15
40493	TDA7396	PHILIPS	45W/2W BRIDGE CAR RADIO AMPLIFIER	Multiwatt11
40716	TDA7560	ST(SGS)	4*45WBRIDGE CAR RADIO AMPLIF PLUS HSD	DIP
33698	TDA8551	PHILIPS	1 W BTL audio amplifier with digital volume control	8P/DIP
22845	TEA1062A	UTC	Low voltage transmission circuits with dialler interface	16P/DIP
11394	TEA2025B	ST(SGS)	Stereo Audio Amplifier	16P/DIP
40228	TPA2001D2PW	T.I.	1-W Filterless Stereo Class-D Audio Power Amplifier	24P/TSSOP
41823	TPA6203A1GQVR	T.I.	1.25-W MONO FULLY DIFFERENTIAL AUDIO POWER AMPLIFIER	MICROSTAR JUNIOR™(GQV)
41820	TPA6211A1DGN	T.I.	3.1-W MONO FULLY DIFFERENTIAL AUDIO POWER AMPLIFIER	MSOP PowerPAD™(DGN)
41817	TPA6211A1DRB	T.I.	3.1-W MONO FULLY DIFFERENTIAL AUDIO POWER AMPLIFIER	SMALL OUTLINE(DRB)

比较器 IC 比较器 IC

详细产品规格 - 请点击 cn.100y.com.tw

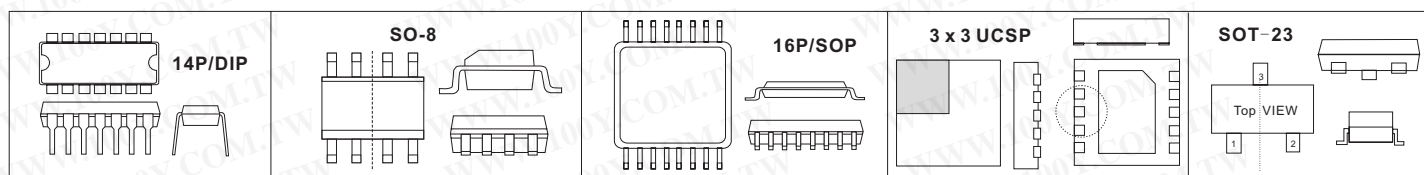

100Y 编号	厂商编号	制造厂商	说明	Pins/Package
32553	AD790JN	ADI	Fast, Precision Comparator	8P/DIP
44661	AD790JR	ADI	比较器 IC	8P/SOIC
32696	AD8561ANZ	ADI	Ultrafast 7 ns Single Supply Comparator	8P/DIP
32595	AD8561AR	ADI	Ultrafast 7 ns Single Supply Comparator	8P/SOIC
1381	APL4221KC	Anpec	Dual op, Dual comparator & adj. Precision shunt regulator	16P/SOP
32752	CA3290E	Intersil	BIMOS Dual Voltage Comparators with MOSFET Input, Bipolar Output	8 Ld PDIP
41632	CA358M96	HARRIS	比较器 IC	8P/SOIC
29038	EL2252CN		比较器 IC	14P/DIP
22586	HA17339P	HITACHI	Quadruple Comparators	14P/DIP
40479	HA17393A-E	RENESAS	Dual comparator(Pb Free)	8P/DIP
28911	KA319	Fairchild	High Speed Dual Comparator	14P/DIP
42623	LM1458N(无铅)	N.S	Dual Op Amp.	8P-DIP
42624	LM1877M-9 (无铅)	N.S	DualAudioPowerAmplifier	14P/DIP
23867	LM211	ST(SGS)	VOLTAGE COMPARATORS	8P/SOIC
22655	LM211D	T.I.	VOLTAGE COMPARATORS	8P/SOP
39209	LM2901D	N.S	Low Power Low Offset Voltage Quad Comparators	14P/SOP
40123	LM2901D	ON-Semi.	Single Supply Quad Comparators	14P/SOIC
39350	LM2901N	T.I.	QUAD DIFFERENTIAL COMPARATORS	14P/DIP
4808	LM2901N	N.S	Quad voltage comparator (MC3302P)	14P/DIP
41892	LM2903D	ON-Semi.	Low Offset Voltage Dual Comparators	SOIC-8
41893	LM2903DMR2G	ON-Semi.	Low Offset Voltage Dual Comparators	Micro8
7675	LM2903MX	N.S	Low Offset Voltage Dual Comparator	8P/SOIC
33420	LM2903N	ST(SGS)	Low power dual voltage comparator	8P/DIP
32201	LM2903N	Fairchild	Low power dual voltage comparator	8P/DIP
3978	LM2903N	N.S	Low power dual voltage comparator	8P/DIP
41894	LM2903NG	ON-Semi.	Low Offset Voltage Dual Comparators	PDIP-8
19288	LM2951ACMX	N.S	Adjustable Micropower Voltage Regulators	8P/SMD
40212	LM306D	T.I.	DIFFERENTIAL COMPARATOR WITH STROBES	8P/SOP
1364	LM311D	MOTOROLA	Highly Flexible Voltage Comparator	8P/SOIC
30194	LM311DT	ST(SGS)	Highly Flexible Voltage Comparator	8P/SOIC
18487	LM311H	N.S	Voltage Comparator	8P/TO-5
34758	LM311M	N.S	Voltage Comparator	8P/SOIC
3826	LM311N	N.S	Voltage comparator	8P/DIP
1148	LM311N	ST(SGS)	Voltage comparator	8P/DIP
25938	LM311P	T.I.	Voltage comparator	8P/DIP
34763	LM319D	PHILIPS	Dual voltage comparator	14P/SOIC
34762	LM319M	N.S	High Speed Dual Comparator	14P/SOIC
16456	LM319MX	N.S	Hi-speed dual comparator	14P/SOIC
6659	LM319N	N.S	High Speed Dual Comparator	14P/DIP
7514	LM3302N	N.S	Low power low offset voltage quad comparator	14P/DIP
28486	LM339AM	N.S	比较器 IC	14P/SOP
34766	LM339AN	PHILIPS	Quad voltage comparator	14P/DIP
1367	LM339D	MOTOROLA	Quad Single Supply Comparator	14P/SOIC
22662	LM339DR	T.I.	QUAD DIFFERENTIAL COMPARATORS	14P/SOIC
19295	LM339M	N.S	Low Power Low Offset Voltage Quad Comparators	14P/SO



放大器IC

比较器 IC

详细产品规格 - 请点击 cn.100y.com.tw

100Y 编号	厂商编号	制造厂商	说明	Pins/Package
34765	LM339M	N.S	Low Power Low Offset Voltage Quad Comparators	14P/SOIC
22663	LM339MX	N.S	Low Power Low Offset Voltage Quad Comparators	14P/SOP
33726	LM339N	T.I.	QUAD DIFFERENTIAL COMPARATORS	14/DIP
19296	LM339N	ST(SGS)	LOWPOWER QUAD VOLTAGE COMPARATORS	14P/DIP
4946	LM339N	MOTOROLA	Quad single supply comparator	14P/DIP
17076	LM360H	N.S	High Speed Differential Comparator	8P/TO-5
1176	LM360N	N.S	High speed differential comparator	8P/DIP
34440	LM392M	N.S	Low Power Operational Amplifier/Voltage Comparator	SOP/8P
34441	LM392N	N.S	Low Power Operational Amplifier/Voltage Comparator	DIP/8P
1375	LM393D	PHILIPS	飞利浦 Low Offset Voltage Dual Comparator	8P/SOP
41903	LM393DMR2G	ON-Semi.	Low Offset Voltage Dual Comparators	Micro8
42896	LM393DP	PHILIPS	Low Offset Voltage Dual Comparator	8P/TSSOP
22667	LM393DR	T.I.	DUAL DIFFERENTIAL COMPARATORS	8P/SOP
42855	LM393DT	ST(SGS)	DUAL DIFFERENTIAL COMPARATORS	8P/SOIC
40670	LM393M	Fairchild	Dual differential comparator	8P/SOP
22668	LM393MX	N.S	Low Power Low Offset Voltage Dual Comparators	8P/SOIC NARROW
1184	LM393N	N.S	Dual differential comparator	8P/DIP
29376	LM393N	ST(SGS)	Dual differential comparator	8P/DIP
22588	LM393N	HITACHI	Dual Comparator	8P/DIP
41904	LM393NG	ON-Semi.	Low Offset Voltage Dual Comparators	PDIP-8
19284	LM393P	T.I.	Low Power Low Offset Voltage Dual Comparator	8P/DIP
39345	LM393PW	T.I.	Low Power Low Offset Voltage Dual Comparator	8P/TSSOP
22777	LP339M	N.S	Ultra-Low Power Quad Comparator SOIC	SOIC/14P
16221	LT1016CN8	Linear-Tech.	Operates off Single +5V Supply , or ± 5V	8P/DIP
42354	MAX3787ABL-T	MAXIM	1Gbps to 12.5Gbps Passive Equalizer for Backplanes and Cable	4 UCSP-4
42368	MAX4016ESA	MAXIM	Low-Cost, High-Speed, Single-Supply Op Amps with Rail-to-Rail Outputs	8 SO
42371	MAX4020ESD+T	MAXIM	Low-Cost, High-Speed, Single-Supply Op Amps with Rail-to-Rail Outputs	16 QSOP
19685	MAX4372TEUK-T	MAXIM	Low-Cost, UCSP/SOT23, Micropower, High-Side Current-Sense Amplifier with Voltage Output	5P/SOT23-5
42429	MAX4375TEUB	MAXIM	Low-Cost, Micropower, High-Side Current-Sense Amplifier + Comparator + Reference ICs	10 µMAX
42543	MAX8546EUB-T	MAXIM		
35041	MAX961ESA	MAXIM	Single/Dual/Quad, Ultra-High-Speed, +3V/+5V, Beyond-the-Rails Comparators	8P/SO
35042	MAX962ESA	MAXIM	Single/Dual/Quad, Ultra-High-Speed, +3V/+5V, Beyond-the-Rails Comparators	8P/SO
42207	MAX9718AEBL-T*	MAXIM	Low-Cost, Mono/Stereo	3 x 3 UCSP
42204	MAX9718AETB	MAXIM	Low-Cost, Mono/Stereo	10 TDFN-EP**
41814	MAX9718AEUB	MAXIM	Low-Cost, Mono/Stereo,	10 µMAX-EP**
41815	MAX9719AETE	MAXIM	Low-Cost, Mono/Stereo	16 TQ FN - E P **
23248	NE521N	PHILIPS	High-speed dual-differential comparator/sense amp	DIP-14P
40855	TA75393P	TOSHIBA	Dual comparator	8P/DIP
33250	TL3016ID	T.I.	ULTRA-FAST LOW-POWER	14P/SOIC
33311	TLC3702CD	T.I.	DUAL MICROPOWER LinCMOSE VOLTAGE COMPARATORS	8P/SOIC
33344	TLC3704ID	T.I.	QUAD MICROPOWER LinCMOS TM VOLTAGE COMPARATORS	14SOIC
33346	TLC372ID	T.I.	LinCMOS TM DUAL DIFFERENTIAL COMPARATORS	8P/SOIC
45192	TLC374CN	T.I.	比较器 IC	PDIP-14

OP 放大器 IC OP 放大器 IC

详细产品规格 - 请点击 cn.100y.com.tw

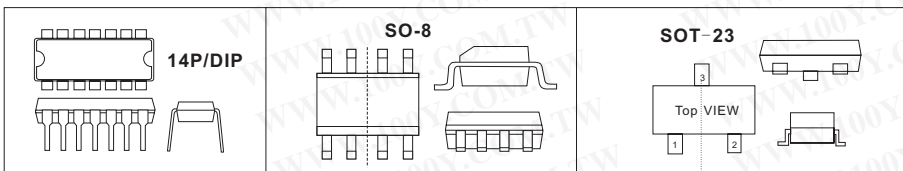

100Y 编号	厂商编号	制造厂商	说明	Pins/Package
49316	2SC2351	NEC	HIGH FREQUENCY LOW NOISE AMPLIFIER	3P/SOT-23
32291	AD549JH	ADI	Ultralow Input Bias Current Operational Amplifier	8P/TO-99
15688	AD549LH	Allegro	Ultralow Input Bias Current Operational Amplifier	8P/TO-99
32341	AD594AQ	ADI	Thermocouple Amplifier	14P/DIP
32474	AD595AQ	ADI	Thermocouple Amplifiers	14P/DIP
18419	AD595CQ	ADI	Thermocouple Amplifier	14P/DIP
32373	AD648JN	ADI	Dual Precision, Low Power BiFET Op Amp	8P/DIP
32395	AD704JN	ADI	Quad Picoampere Input Current Bipolar Op Amp	14P/DIP
32396	AD705JR	ADI	Picoampere Input Current Bipolar Op Amp	8P/SOIC
32397	AD708JN	ADI	Ultralow Offset Voltage Dual Op Amp	8P/DIP
16406	AD711JNZ	ADI	Precision, Low Cost, High Speed, BiFET Op Amp	8P/DIP
32399	AD711JR	ADI	Precision, Low Cost, High Speed, BiFET Op Amp	8P/SOIC
32401	AD711KN	ADI	Precision, Low Cost, High Speed, BiFET Op Amp	8P/DIP
13710	AD712AQ	ADI	Dual-Precision, Low-Cost, High-Speed, BiFET Op Amp	8P/DIP



服务专线: 台湾: 886-3-5753170
 传 真: 台湾: 886-3-5753172
 E-mail: 台湾: sale@100y.com.tw

深圳: 86-755-83298787
 深圳: 86-755-83640655
 深圳: 100y@163.com

上海: 86-21-34970699
 上海: 86-21-64605107
 上海: 100y-1@163.com

放大器IC

OP 放大器 IC

详细产品规格 - 请点击 cn.100y.com.tw

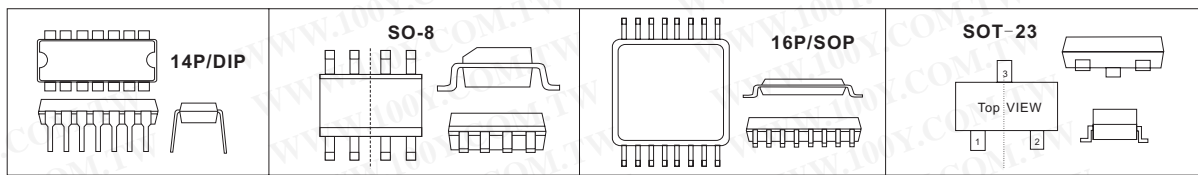

100Y 编号	厂商编号	制造厂商	说明	Pins/Package
16407	AD712JNZ	ADI	Dual-Precision, Low-Cost, High-Speed, BiFET Op Amp	8P/DIP
32408	AD712JR	ADI	Dual-Precision, Low-Cost, High-Speed, BiFET Op Amp	8P/SOIC
36448	AD712KR	ADI	Dual-Precision, Low-Cost, High-Speed, BiFET Op Amp	8P/SOIC
28346	AD713JNZ	ADI	OP 放大器 IC	14P/DIP
32440	AD744JN	ADI	Precision, 500 ns Settling BiFET Op Amp	8P/DIP
32554	AD797ANZ	ADI	Ultralow Distortion,Ultralow Noise Op Amp	8P/DIP
32555	AD797AR	ADI	Ultralow Distortion,Ultralow Noise Op Amp	8P/SOIC
39217	AD797BN	ADI	Ultralow Distortion,Ultralow Noise Op Amp	8P/DIP
32556	AD8001AR	ADI	800 MHz, 50 mW Current Feedback Amplifier	8P/SOIC
32557	AD8009AR	ADI	1 GHz, 5,500 V/μs Low Distortion Amplifier	8P/SOIC
32558	AD8011AN	ADI	300 MHz, 1 mA Current Feedback Amplifier	8P/DIP
32559	AD8017AR	ADI	Dual High Output Current,High Speed Amplifier	8P/SOIC
32560	AD8041AN	ADI	160 MHz Rail-to-Rail Amplifier with Disable	8P/DIP
46908	AD8047AN	ADI	250 MHz, GENERAL PURPOSE VOLTAGE FEEDBACK OP AMPSOP 放大器 IC	DIP-8P
15464	AD8047AR	Allegro	250 MHz, GENERAL PURPOSE VOLTAGE FEEDBACK OP AMPS	8P/SOIC
39043	AD8048AN	ADI	260MHz, General Purpose Voltage Feedback Op Amps	8P/DIP
43068	AD8048AR	ADI	250 MHz, General PurposeVoltage Feedback Op Amps	8P/SOP
42921	AD8048AR	ADI	260MHz, General Purpose Voltage Feedback Op Amps	8P/SOP
32561	AD8057AR	ADI	Low Cost, High Performance Voltage Feedback, 325 MHz Amplifiers	8P/SOIC
32562	AD8058AR	ADI	Low Cost, High Performance Voltage Feedback, 325 MHz Amplifiers	8P/SOIC
39088	AD8061AR	ADI	Low Cost, 300 MHz Rail-to-Rail Amplifiers	SO-8
39057	AD8061ART	ADI	Low Cost, 300 MHz Rail-to-Rail Amplifiers	SOT-23
39056	AD8062AR	ADI	Low Cost, 300 MHz Rail-to-Rail Amplifiers	8P/SOIC
32563	AD811AN	ADI	High Performance Video Op Amp	8P/DIP
49126	AD8132ARZ	ADI	Low Cost, High SpeedDifferential Amplifier	8P/SOIC
32564	AD8138AR	ADI	Low Distortion Differential ADC Driver	8P/SOIC
32566	AD817AN	ADI	High Speed, Low Power Wide Supply Range Amplifier	8P/DIP
32567	AD817AR	ADI	High Speed, Low Power Wide Supply Range Amplifier	8P/SOIC
32568	AD818AN	ADI	Low Cost, Low Power Video Op Amp	8P/DIP
32569	AD820AR	ADI	Single Supply, Rail to Rail Low Power FET-Input Op Amp	8P/SOIC
32570	AD822AN	ADI	Single Supply, Rail-to-Rail Low Power FET-Input Op Amp	8P/DIP
48747	AD822ARZ	ADI	Single Supply, Rail-to-Rail Low Power FET-Input Op Amp	8P/DIP
32571	AD823AN	ADI	Dual, 16 MHz, Rail-to-Rail FET Input Amplifier	8P/DIP
32572	AD825AR	ADI	Low Cost, General Purpose High Speed JFET Amplifier	8P/SOIC
32573	AD826AN	ADI	High-Speed, Low-Power Dual Operational Amplifier	8P/DIP
32575	AD827JN	ADI	High Speed, Low Power Dual Op Amp	8P/DIP
32576	AD828AN	ADI	Dual, Low Power Video Op Amp	8P/DIP
15347	AD829JNZ	ADI	ROHS_HIGH-SPEED, LOW-NOISE VIDEO OP AMP	8P/DIP
32582	AD829JR	ADI	HIGH-SPEED, LOW-NOISE VIDEO OP AMP	8P/SOIC
32584	AD841JN	ADI	Wideband, Unity-Gain Stable, Fast Settling Op Amp	14P/DIP
32585	AD844AN	ADI	60 MHz, 2000 V/μs Monolithic Op Amp	8P/DIP
32586	AD845JN	ADI	Precision, 16 MHz CBFET Op Amp	8P/DIP
32587	AD845KN	ADI	Precision, 16 MHz CBFET Op Amp	8P/DIP
1212	AD847JNZ	ADI	50MHz bandwidth, high speed op-amp	8P/DIP
32588	AD847JR	ADI	50MHz bandwidth, high speed op-amp	8P/SOIC
41710	AD848JR	ADI	725MHz bandwidth, high speed op-amp	R-8
32590	AD8541AR	ADI	General Purpose CMOS Rail-to-Rail Amplifiers	8P/SOIC
32592	AD8542AR	ADI	General Purpose CMOS Rail-to-Rail Amplifiers	8P/SOIC
48251	AD8605ARTZ-REEL7	ADI	AD_SOT-23/5P	SOT-23/5P
48166	AD8620AR	ADI	AD_OP 放大器 IC	8-Lead SOIC
48167	AD8620BR	ADI	AD_OP 放大器 IC	8-Lead SOIC
32598	AD9617JN	ADI	Low Distortion, Precision,Wide Bandwidth Op Amp	8P/DIP
39080	AD9617JR	ADI	Low Distortion, Precision,Wide Bandwidth Op Amp	8P/SOIC
29233	BA4560F-E2	ROHM	Dual High Slew Rate Op Amp.	SOP8
39523	BUF634P	BB	250mA HIGH-SPEED BUFFER	DIP-8
37594	BUF634U	BB	250mA HIGH-SPEED BUFFER	SO-8 Plastic
3893	CA3080E	HARRIS	2MHz, operational transconductance amplifier (OTA)	8P/DIP
6846	CA3130E	Intersil	15MHz, BiMOS operational amplifier with MOSFET input/CMOS output	8P/DIP
41211	CA3140		4.5MHz, BiMOS Operational Amplifier with MOSFET Input/Bipolar Output	8 Pin Metal Can
19318	CA3140E	Intersil	4.5MHz, BiMOS operational amplifier with MOSFET input/bipolar output	8P/DIP
32745	CA3140M	Intersil	4.5MHz, BiMOS operational amplifier with MOSFET input/bipolar output	8P/SOIC
32747	CA3140T	Intersil	4.5MHz, BiMOS Operational Amplifier with MOSFET Input/Bipolar Output	8 Pin Metal Can
32593	AD8544AR	ADI	General Purpose CMOS Rail-to-Rail Amplifiers	14P/SOIC





OP 放大器 IC

详细产品规格 - 请点击 cn.100y.com.tw

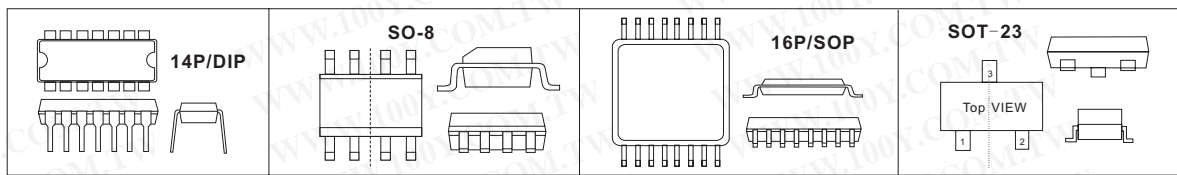

100Y 编号	厂商编号	制造厂商	说明	Pins/Package
32749	CA3160E	Intersil	4MHz, BiMOS Operational Amplifier with MOSFET Input/CMOS Output	8 Ld PDIP
19319	CA3240E	Intersil	OP 放大器 IC	8P/DIP
32751	CA3260E	Intersil	4MHz, BiMOS Operational Amplifier with MOSFET Input/CMOS Output	8 Ld PDIP
17077	CA3420E	Intersil	0.5MHz, Low Supply Voltage, Low Input Current BiMOS Operational Amplifier	8P/DIP
33289	CT1UM35VBV	T.I.	LinCMOSE PROGRAMMABLE LOW-POWER OPERATIONAL AMPLIFIERS	8P/DIP
33069	EL2020CN	Elantec	50 MHz Current Feedback Amplifier	8P/DIP
33071	EL2044CN	Elantec	Low Power/Low Voltage 120MHz Unity-Gain Stable Operational Amplifier	8-Pin P-DIP
33073	EL2045CN	Elantec	Low-Power 100 MHz Gain-of-2 Stable Operational Amplifier	8-Pin P-DIP
16852	EL2072CS	Elantec	730 MHz Closed Loop Buffer	8P/SOIC
41225	EL2075CS	Elantec	Gain-of-10 Stable Operational Amplifier	8P/SOIC
41231	EL2120CS	Elantec	FEEDBACK AMPLIFIER	8P/PDIP
40125	EL2157CS	Elantec	125 MHz Single Supply, Clamping Op Amps	8P/SOIC
33417	EL2160CS	Elantec	130 MHz Current Feedback Amplifier	8-Pin SOIC
33418	EL2180CS	Elantec	250MHz / 3mA Current Mode Feedback Amplifiers	8-Pin SO
41243	EL2245CN	Elantec	LOW-POWER STABLE OP AMP	8P/DIP
33419	EL2250CS	Elantec	125MHz Single Supply Dual/Quad Op Amps	8-Pin SO
41235	EL2270CN	Elantec	70MHz/1mA Current Mode Feedback Amplifier	8P-PDIP
41240	EL2286CS	Elantec	CURRENT MODE FEEDBACK AMP W/DISABLE	8P/PDIP
41241	EL2286CS	Elantec	CURRENT MODE FEEDBACK AMP W/DISABLE	8P/PDIP
41242	EL2386CS	Elantec	TRIPLE CURRENT FEEDBACK AMP W/DISABLE	16P/SIOC
49747	EL2444CS	Elantec	OP 放大器 IC	14P-SOIC
33077	EL2445CN	Elantec	Dual/Quad Low-Power 100MHz Gain-of-2 Stable Op Amp	14-Pin P-DIP
41244	EL400CN	Elantec	CURRENT FEEDBACK AMPLIFIER	8P/DIP
2731	HA17324AP	HITACHI	Low power quad op amp.	14P/DIP
22587	HA17358AQ	HITACHI	Dual Operational Amplifier	8P/DIP
22589	HA17458-E	HITACHI	Dual Operational Amplifier	8P/DIP
13954	HA17558	HITACHI	DUAL OPERATIONAL AMPLIFIERS(DIP-8)	8P/DIP
19278	HA17741	HITACHI	Operational Amplifier	8P/DIP
37713	HA3-2525-5	HARRIS	OP-AMP	8P/DIP
33236	HA3-2539-5	Intersil	600MHz, Very High Slew Rate Operational Amplifier	14 Ld PDIP
20074	HFA1110IB	Intersil	750MHz, Low Distortion Unity Gain, Closed Loop Buffer	8P-SOIC
18171	ICL7611BCPA	Intersil	1.4MHz Low Power CMOS Op Amp.	8P-DIP
33610	ICL7611DPCPA	Intersil	Low Power CMOS Operational Amplifier	8P-DIP
22618	ICL7621DPCPA	HARRIS	Dual, Low Power CMOS Operational Amplifiers	8P/DIP
29068	ICL7650SCPD	Intersil	2MHz, Super Chopper-Stabilized Operational Amplifier	14 Ld PDIP
19326	KA3403	Fairchild	OP 放大器 IC	14P/DIP
45650	KIA358F	KEC	DUAL OPERATIONAL AMPLIFIER	8P/SOIC(FLP-8)
34543	L272	ST(SGS)	DUAL POWER OPERATIONAL AMPLIFIERS	16P/DIP
42390	L2720	ST(SGS)	LOWDROP DUAL POWER OPERATIONAL AMPLIFIERS	16PDIP
44983	LF251N	ST(SGS)	OP 放大器 IC	8P/DIP
44984	LF251S	ST(SGS)	OP 放大器 IC	SO-8P
7168	LF347D	ST(SGS)	QUAD GENERAL-PURPOSE JFET-INPUT OPERATIONAL AMPLIFIER	14P/SOIC
22650	LF347MX	N.S	Quad Operational Amplifier	14P/SOP
32183	LF347N	ST(SGS)	Quad Operational Amplifier, Internally Compensated, JFET Input	14P/DIP
1167	LF347N	N.S	Quad Operational Amplifier, Internally Compensated, JFET Input	14P/DIP
1369	LF351MD	N.S	BIFET op amp.(Wide Bandwidth JFET Input Operational Amplifier)	8P/SOIC
23270	LF351MX	N.S	JFET Input Operational Amplifier	8P/SOP
1170	LF351N	ST(SGS)	BIFET op amp.(wide bandwidth)JFET input operational amplifier)	8P/DIP
16515	LF353MX	N.S	Dual BIFET op amp.	8P/SOP
3748	LF353N	N.S	Wide Bandwidth Dual JFET Input Operational Amplifier	8P/DIP
18586	LF353P	T.I.	Dual BIFET op amp.	8P/DIP
1172	LF355N	N.S	Wide bandwidth single J-TET operational amplifier	8P/DIP
44982	LF356BH	N.S	OP 放大器 IC	8P/Metal Can
1370	LF356MD	N.S	JFET input operational amplifiers. (wide band)	8P/SOIC
1173	LF356N	N.S	Wide bandwidth single J-TET operational amplifier	8P/DIP
1371	LF357MD	N.S	JFET input operational amplifiers.(wide band decom.)	8P/SOIC
3827	LF357N	N.S	Wide bandwidth single J-TET operational amplifier	8P/DIP
40131	LF411ACN	N.S	Low Offset, Low Drift JFET Input Operational Amplifier	8P/DIP
1186	LF411CN	N.S	Low Offset, Low Drift JFET Input Operational Amplifier	8P/DIP
13225	LF412CN	N.S	LOW OFFSET DRIFT JFET DUAL OP	8P/DIP
6713	LF441CN	N.S	Low power JFET input operational amplifier	8P/DIP
16514	LF441D	N.S	Low-Power JFET input OP	8P/SOIC
10349	LF442CN	N.S	Dual Low Power JFET input OP Amp.	8P/DIP



放大器IC

OP 放大器 IC

详细产品规格 - 请点击 cn.100y.com.tw

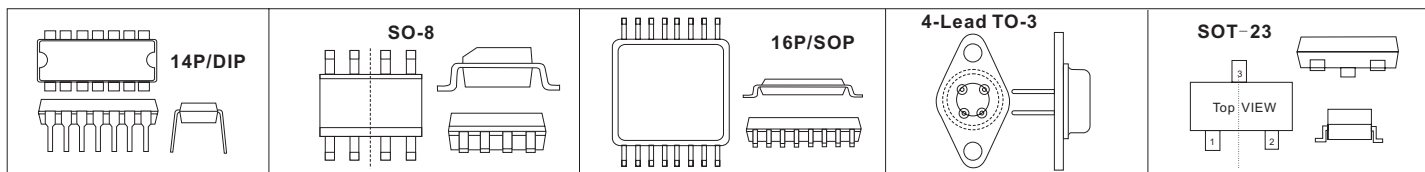

100Y 编号	厂商编号	制造厂商	说明	Pins/Package
6714	LF444CN	N.S	Quad low power JFET input Operational Amplifier.	14P/DIP
18840	LH0042CH	N.S	Low Cost Fet Op Amp	8-P/TO-99
18467	LM10CH	N.S	Operational Amplifier and Voltage Reference	8P/TO-5
34749	LM10CLN	N.S	OP 放大器 IC 14P/DIP	14P/DIP
34657	LM12CLK	N.S	80W Operational Amplifier	4-Lead TO-3
23754	LM13080N	N.S	Voltage-Feedback Operational Amplifier	8P/DIP
6872	LM13600N	N.S	Dual operational transconductance amplifiers with linearizing diodes and buffers	16P/DIP
28703	LM143H	N.S	High Voltage Operational Amplifier	8P/H08C
28416	LM1458CM	Fairchild	OP 放大器	SOP-8P
28224	LM1458M	ST(SGS)	Dual op amp	8P/SOP
7617	LM1458M	N.S	Dual op amp	8P/SOIC
15573	LM1558H	HITACHI	Dual operational amplifier	8P/TO-5
6661	LM1558J	HITACHI	Dual operational amplifier	8P/DIP
39069	LM158D	ST(SGS)	Low Power Dual operational amplifier	SO8
22654	LM207HM	Fairchild	Operational Amplifiers	8P/TO-99
43973	LM208AH	N.S	OP 放大器 IC	TO-99
48237	LM224D	T.I.	Quad low power operational amplifier	14P-SO
22255	LM224D	N.S	Quad low power operational amplifier	14P/SO
38854	LM224N	ST(SGS)	Low Power Quad OP AMP	14P/DIP
28469	LM224N	T.I.	OP 放大器	14P/DIP
4965	LM224N	N.S	Quad low power operational amplifier	14P/DIP
22656	LM258P	T.I.	DUAL OPERATIONAL AMPLIFIERS	8P/PDIP
41891	LM2902N	ON-Semi.	Low power quad operational amplifier	14P/DIP
40338	LM2902N	ST(SGS)	Low power quad operational amplifier	14P/DIP
1248	LM2902N	T.I.	Quad, 1MHz, operational amplifiers	14P/DIP
41895	LM2904DR2	ON-Semi.	Single Supply Dual Operational Amplifiers	SO-8
40936	LM2904DR2G	ON-Semi.	Single Supply Dual Operational Amplifiers	SO-8
1250	LM2904N	N.S	Dual low power operational amplifier	8P/DIP
34743	LM2904P	T.I.	DUAL OPERATIONAL AMPLIFIERS	8P/DIP
18483	LM301AH	N.S	Operational Amplifiers	8P/TO-5
22658	LM301AN	N.S	Operational Amplifiers	8P/DIP
1144	LM301AP	T.I.	Improved Operational Amplifiers	8P/DIP
28223	LM307N	N.S	Operational Amplifiers	8P/DIP
15330	LM308AH	N.S	Precision op amp	8P/TO-99
39477	LM308AN	N.S	Precision Operational amplifiers	8P/DIP
44257	LM308H	N.S	OP 放大器 IC	8P/TO-99
1145	LM308N	N.S	Precision Operational amplifier	8P/DIP
1147	LM310N	N.S	Non-invert. Op amp. /voltage follower	8P/DIP
18492	LM318H	N.S	Operational Amplifiers	8P/TO-5
16455	LM318MX	N.S	Operational Amplifiers	8P/SOIC
19290	LM318N	N.S	Operational Amplifiers	8P/DIP
1152	LM318P	T.I.	SINGLE HIGH-SPEED OPERATIONAL AMPLIFIER	8P/DIP
41899	LM324ADR2	ON-Semi.	Single Supply QuadOperational Amplifiers	SOIC-14
19291	LM324D	T.I.	Quadruple OP Amplifier IC	14P/SOIC
41900	LM324DR2G	ON-Semi.	Single Supply QuadOperational Amplifiers	SOIC-14
39188	LM324DT	ST(SGS)	Low power quad op amp.	14P/SOIC
22659	LM324MX	N.S	Low Power Quad Operational Amplifiers	14P/DIP
35207	LM324N	ST(SGS)	Low power quad op amp.	14P/DIP
19292	LM324N	N.S	Low power quad op amp.	14P/DIP
19293	LM324N	T.I.	Low power quad op amp.	14P/DIP
3977	LM346N	N.S	Programmable Quad Operational Amplifier	16P/DIP
1168	LM348N	N.S	Quad 741 op amp.	14P/DIP
22664	LM358DR	T.I.	DUAL OPERATIONAL AMPLIFIERS	8P/SOIC
1372	LM358DT	ST(SGS)	Dual low power operational amplifier	8P/SOP
44985	LM358H	N.S	OP 放大器 IC	TO-5, 8-Pin Metal Can
22665	LM358MX	N.S	Low Power Dual Operational Amplifiers	8P/SOP
1174	LM358N	N.S	Dual low power operational amplifier	8P/DIP
28470	LM358N	ST(SGS)	ST_OP 放大器	8P/DIP
19283	LM358P	T.I.	Dual OP Amp.	8P/DIP
6554	LM359N	N.S	Dual, High Speed, Programmable, Current Mode (Norton) Amplifiers	14P/DIP
6556	LM3900N	N.S	QUADRUPLE OPERATIONAL AMPLIFIER	14P/DIP
7359	LM4136CN	N.S	Quad high performance op-amp(CUADRUPLE OPERACIONAL BAJO RUIDO)	14P/DIP
48147	LM4558D	HTC Korea	OP 放大器 IC	SOP-8P





OP 放大器 IC

详细产品规格 - 请点击 cn.100y.com.tw

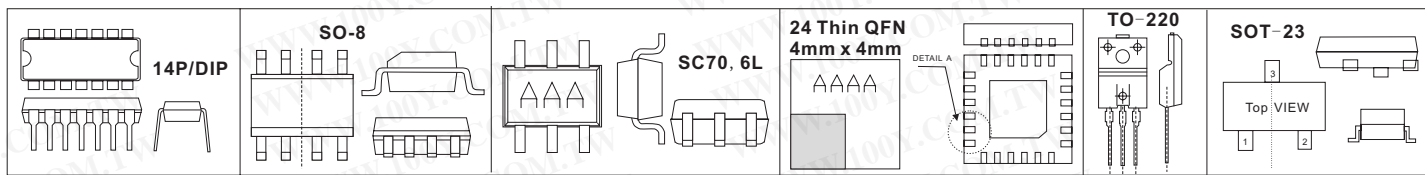

100Y 编号	厂商编号	制造厂商	说明	Pins/Package
28050	LM6134AIN	N.S	Dual and Quad Low Power 10 MHz Rail-to-Rail I/O Operational Amplifiers	8P/DIP
37021	LM6142BIN	N.S	High Speed/Low Power 17 MHz Rail-to-Rail Input-Output Operational Amplifiers	8-Pin Molded DIP
1292	LM6361N	N.S	High Speed Operational Amplifier, 5~32V supply volt. 50MHz 300V/Us	8P/DIP
1293	LM6364N	N.S	High Speed Operational Amplifier, 5~32V supply volt. 175MHz 300V/uS	8P/DIP
1294	LM6365N	N.S	High Speed Operational Amplifier, 5~32V supply volt. 725MHz 300V/uS	8P/DIP
37107	LM675T	N.S	Power Operational Amplifier	TO-220
22670	LM7171AIMX	N.S	Very High Speed, High Output Current, Voltage Feedback Amplifier	8P/SOP
1379	LM741CD	ST(SGS)	Operational Amplifier	8P/SOIC
19637	LM741CH	N.S	OP AMP HI PERFORMANCE	8P/TO-99
3766	LM741CN	N.S	Operational Amplifier	8P/DIP
11708	LM741H	N.S	Operational Amplifier	8P/TO-99
41359	LM741N	N.S	Operational Amplifier	8P/DIP
1380	LM748CD	ST(SGS)	Operational Amplifier	8P/SOIC
41905	LM833DR2G	ON-Semi.	Low Noise, Audio Dual Operational Amplifier	soic-8
22674	LM833MX	N.S	Dual Audio Operational Amplifier	8P/SOP
6782	LM833N	N.S	Dual low noise, audio amplifier	8P/DIP
15654	LMC6001BIN	N.S	Ultra Ultra-Low Input Current Amplifier	8P/DIP
49662	LMC6064AIM	N.S	OP 放大器 IC	SO-14
32276	LMH6639MA	N.S	190MHz Rail-to-Rail Output Amplifier with Disable	8P/SOP
16489	LMV324MT	N.S	Quad op amp	14P/TSSOP
41365	LMV722MX	N.S	10MHz, Low Noise, Low Voltage, and Low Power	SOP/8P
48854	LMV931IDBVR	T.I.	OPERATIONAL AMPLIFIER	SOT23-5
14007	LT1006CN8	Linear-Tech.	Precision, Single Supply, Operational Amp.	8P/DIP
47275	LT1007CN8	Linear-Tech.	OP 放大器 IC	DIP-8
7992	LT1013CN8	Linear-Tech.	Dual precision op amp.	8P/DIP
7672	LT1013DS8	Linear-Tech.	Dual precision op amp.	8P/SOIC
19688	LT1028CN8	Linear-Tech.	Ultralow Noise Precision High Speed Op Amps	8P/DIP
13082	LT1078CN8	Linear-Tech.	BW-3dB 2MHz / Aol V 7mV / SR V 4 us / V(offset) 0.06mV	8P/DIP
30046	LT1079CN	Linear-Tech.	L.T_OP 放大器 IC	14P/DIP
16639	LT1097CN8	Linear-Tech.	Low Cost, Low Power Precision Op Amp	8P/DIP
23571	LT1114CN	Linear-Tech.	Quad Low Power Precision, Picoamp Input Op Amp	14P/DIP
28415	LT1124CS8	Linear-Tech.	OP 放大器	8P/SOIC
3749	LT1227CN8	Linear-Tech.	140MHz, Video Current Feedback Amp	8P/DIP
17624	LT1360	Linear-Tech.	50MHz, 800V/ms Op Amp	8P/DIP
48179	LT2179CS	Linear-Tech.	LT_14-SO 放大器 IC	14-SO
11505	LTC1151CN8	Linear-Tech.	Dual ±15V Zero Drift OP Amp. With Internal Cap.	8P/DIP
24665	M4558LD		Dual Operational Amp	
24666	M4558M-TE3		Dual Operational Amp	
19945	MA17	APEX	17-Ch. High Volt. Power OP Amp.	100P Quad Flat Pack-EK
42075	MAX1578ETG	MAXIM	Complete Bias and White LED Power Supplies	24 Thin QFN 4mm x 4mm
42078	MAX1584ETJ+	MAXIM	5-Channel Slim DSC Power Supplies	32 Thin QFN
34933	MAX2611EUS	MAXIM	DC-to-Microwave, Low-Noise Amplifier	4P/SOT143
40010	MAX2642EXT-T	MAXIM	900MHz SiGe, High IP3, Low-Noise Amplifiers	6 SC70-6
40012	MAX2643EXT-T	MAXIM	900MHz SiGe, High IP3, Low-Noise Amplifiers	6 SC70-6
40013	MAX2644EXT-T	MAXIM	2.4GHz SiGe, High IP3 Low-Noise Amplifier	6 SC70
42359	MAX3970U/D	MAXIM	10Gbps, 3.3V Low-Power Transimpedance Amplifier with RSSI	Dice
34964	MAX4107ESA	MAXIM	350MHz, Ultra-Low-Noise Op Amps	8P/SO
34965	MAX410CPA	MAXIM	Single/Dual/Quad, 28MHz, Low-Noise, Low-Voltage, Precision Op Amps	8P/DIP
34966	MAX4112ESA	MAXIM	Single/Dual/Quad, 400MHz, Low-Power, Current Feedback Amplifiers	8P/SO
42374	MAX4165EUK-T	MAXIM	High-Output-Drive, Precision, Low-Power, Single-Supply, Rail-to-Rail I/O Op Amps with Shutdown	5 SOT23-5
42425	MAX4232AKA-T	MAXIM	8 SOT23-8	High-Output-Drive, 10MHz, 10V/μs, Rail-to-Rail I/O Op Amps with Shutdown in SC70
34968	MAX427CPA	MAXIM	Low Noise, High-Precision Op Amps	8P/DIP
42800	MAX435CPD	MAXIM	widband transconductance amplifier	14 plastic DIP
42427	MAX435EPD	MAXIM	14 plastic DIP	widband transconductance amplifier
34969	MAX437CPA	MAXIM	Low Noise, High-Precision Op Amps	8P/DIP
29595	MAX4450EVK-T	MAXIM	Op Amps with Rail-to-Rail Outputs	5P/SOP
42435	MAX4491AKA-T	MAXIM	Low-Cost, High-Slew-Rate, Rail-to-Rail I/O Op Amps in SC70	8 SOT23-5
34978	MAX474CPA	MAXIM	Single/Dual/Quad, 10MHz Single-Supply Op Amps	8 Plastic DIP
42464	MAX495CSA+	MAXIM	Single/Dual/Quad, Micropower, Single-Supply Rail-to-Rail Op Amps	8 Plastic DIP





OP 放大器 IC

详细产品规格 - 请点击 cn.100y.com.tw

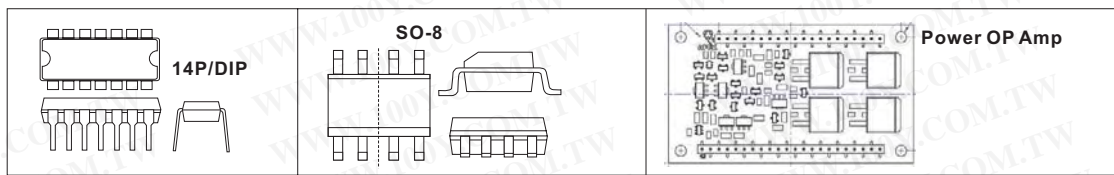

100Y 编号	厂商编号	制造厂商	说明	Pins/Package
41733	MC1458D	ST(SGS)	high performance monolithic dual operational amplifier intended for a wide range of analog	so 8
47597	MC1458DR	T.I.	DUAL GENERAL-PURPOSE OPERATIONAL AMPLIFIERS	8P/SOIC
35172	MC1458P	T.I.	DUAL GENERAL-PURPOSE OPERATIONAL AMPLIFIERS	8P/DIP
4968	MC1458P	MOTOROLA	Dual operational amplifier	8P/DIP
22801	MC3303D	ON-Semi.	Quad Operational Amplifier	14P/SOP
47691	MC33074P	MOTOROLA	OP 放大器 IC	DIP-14P
43076	MC33077D	ON-Semi.	DUAL LOW NOISE OPERATIONAL AMPLIFIER	SO-8
42030	MC33078D	ON-Semi.	Low Noise Dual Operational Amplifier	SOIC-8
35191	MC33171D	ON-Semi.	Single Supply 3V to 44V, Low Power Single Op Amp	8P/SO
35192	MC33171P	ON-Semi.	Single Supply 3V to 44V, Low Power Single Op Amp	8P/DIP
42032	MC33174D	ON-Semi.	SOIC-14	Low Power Quad Op Amp
22708	MC33174P	MOTOROLA	Low Power Operational Amplifiers	14P/PDIP
35193	MC33179D	ON-Semi.	Low Power, Low Noise Quad Operational Amplifier	14P/SOIC
25774	MC33179P	MOTOROLA	Low Power Operational Amplifiers	14P/PDIP
35195	MC33201P	ON-Semi.	Low Voltage, Rail-to-Rail, Single Operational Amplifier	8P/DIP
23869	MC33202D	MOTOROLA	LOW VOLTAGE RAIL-TO-RAIL OP AMPLIFIER	8P/SOIC
40400	MC33202DMR2	MOTOROLA	Rail-to-Rail Operational Amplifiers	Micro-8
42033	MC33202DMR2G	ON-Semi.	Dual Operational Amplifier	Micro8™
42035	MC33202DR2G	ON-Semi.	Dual Channel Operational Amplifier	SOIC-8
42036	MC33204DR2G	ON-Semi.	OPERATIONAL AMPLIFIERS	SOIC-14
33034	MC3403D	MOTOROLA	Quad Low Power Operational Amplifiers	14P/SO
49465	MC3403N	ST(SGS)	LOW POWER QUAD BIPOLAR OPERATIONAL AMPLIFIERS	14P/DIP
7515	MC3403N	T.I.	Quad operational amplifier	14P/DIP
42043	MC34072DR2	ON-Semi.	Dual Op Amp	SOIC8
36340	MC34074D	ON-Semi.	High Slew Rate, Wide Bandwidth, Single Supply Operational Amplifiers	14P/SO
42045	MC34074DR2	ON-Semi.	Single Supply 3.0 V to 44 V Operational Amplifiers	SOIC14
23344	MC4560	UTC	DUAL OPERATIONAL AMPLIFIER	8P/DIP
24669	MCP602-I/P-e3	MICRO-CHIP	Single Supply CMOS Op Amps	8P/DIP
19893	MP230FC	APEX	Power OP Amp.	42P DIP-FC
19894	MP240FC	APEX	Power OP Amp.	42P DIP-FC
19895	MP38CL	APEX	Power OP Amp.	30P DIP-CL
19917	MP39CL	APEX	Power OP Amp.	30P DIP-CL
19919	MSA240	APEX	Pulse Width Modulation Amp.	58P DIP-FD
19918	MSA66	APEX	Pulse Width Modulation Amp.	34P DIP-FD
39639	MX7224KN	MAXIM	CMOS 8-Bit DAC with Output Amplifier	DIP/18P
40200	NE4558D	PHILIPS	Dual general-purpose operational amplifier	8P-SO
7362	NE4558N	N.S	Dual internally compensated op-amp	8P/DIP
32477	NE5532N	PHILIPS	Internally-compensated dual low noise	8P/DIP
7170	NE5532P	T.I.	DUAL LOW-NOISE HIGH-SPEED AUDIO OPERATIONAL AMPLIFIER	8P/DIP
32480	NE5534AN	PHILIPS	Dual and single low noise op amp	8P/DIP
7171	NE5534AP	T.I.	LOW-NOISE OPERATIONAL AMPLIFIER	8P/DIP
32481	NE5534N	PHILIPS	Dual and single low noise op amp	8P/DIP
32483	NE5534P	T.I.	Low Noise OP Amp	8P/DIP
32485	NE5539N	PHILIPS	High frequency operational amplifier	14P/DIP
16432	NE568AN	PHILIPS	150MHz phase-locked loop	20P/DIP
44920	NUM2068M	JRC	OP 放大器 IC	8P/SOP
22767	NJM2100M	JRC	DUAL OPERATIONAL AMPLIFIER	8P/SMD
22771	NJM2904D	JRC	SINGLE-SUPPLY DUAL OPERATIONAL AMPLIFIER	8P/DIP
22772	NJM2904M	JRC	SINGLE-SUPPLY DUAL OPERATIONAL AMPLIFIER	8P/SMD
19689	NJM3404A	JRC	SINGLE-SUPPLY DUAL OPERATIONAL AMPLIFIER	8P/SSOP
42915	NUM386D	JRC	LOW VOLTAGE AUDIO POWER AMPLIFIER	DIP-8
19274	NJM4558D	JRC	Dual Operational Amplifier	8P-DIP
19275	NJM4558DD	JRC	Dual Operational Amplifier	8P-DIP
44921	NJM4560M	JRC	OP 放大器 IC	DMP8
40497	NJM4580M	JRC	OP 放大器 IC	8P/SOP
14551	OP07CDR	T.I.	PRECISION OPERATIONAL AMPLIFIERS	8P/SOIC
1125	OP07CP	T.I.	Low noise, Low offset voltage operational amplifier.	8P/DIP
29305	OP07CP-G	T.I.	Low noise, Low offset voltage operational amplifier.	8P/DIP
27938	OP07CS	ADI	Low noise, Low offset voltage operational amplifier.	8P/DIP
32527	OP07DCSA	MAXIM	Low offset voltage operational amplifier	8 LEAD SMALL OUTLINE
41021	OP11EP	ADI	741-Type Operational Amplifiers	14-Lead Epoxy DIP
41022	OP11EY	ADI	741-Type Operational Amplifiers	14-Lead CERDIP
15649	OP11G	Allegro	Quad Matched 741-Type Operational Amplifiers	14P/DIP



服务专线: 台湾: 886-3-5753170

传 真: 台湾: 886-3-5753172

E-mail: 台湾: sale@100y.com.tw

深圳: 86-755-83298787

深圳: 86-755-83640655

深圳: 100y@163.com

上海: 86-21-34970699

上海: 86-21-64605107

上海: 100y-1@163.com



OP 放大器 IC

详细产品规格 - 请点击 cn.100y.com.tw

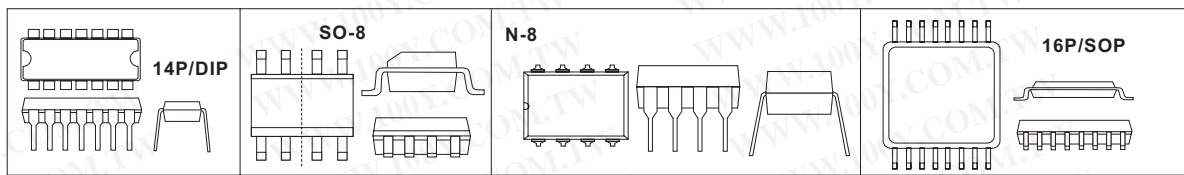

100Y 编号	厂商编号	制造厂商	说明	Pins/Package
33223	OP177FP	ADI	Ultraprecision Operational Amplifier	N-8
1140	OP177GPZ	ADI	Op-amp,precision, low offset	8P/DIP
33225	OP177GS	ADI	Ultraprecision Operational Amplifier	SO-8
33227	OP183GP	ADI	5 MHz Single-Supply Operational Amplifiers	N-8
33228	OP193FP	ADI	Precision, Micropower Operational Amplifier	N-8
11823	OP200GPZ	ADI	A dual low offset, high open-loop gain and low power op-amp	8P/DIP
33230	OP213FP	ADI	Low Noise, Low Drift Single-Supply Operational Amplifiers	N-8
12395	OP213FS	ADI	A low noise, low drift single supply OP. Vcc:+4~36V	8P/SOIC
33327	OP249GP	ADI	JFET High Speed Operational Amplifier	N-8
4960	OP275GP	ADI	Dual,bipolar/JEFT amplifier fea	8P/DIP
40316	OP275GPZ	ADI	Dual,bipolar/JEFT amplifier fea	8P/DIP
29059	OP27EP		Low-Noise,Precision OP AMP.	8P/DIP
40321	OP27EZ	ADI	Low-Noise, Precision Operational Amplifier	8P/DIP
15326	OP27GPZ	ADI	Low-Noise Precision OP	8P/DIP
33334	OP27GS	ADI	Low-Noise, Precision Operational Amplifier	N-8
42396	OP284		Precision Rail-to-Rail Input & Output Operational Amplifiers	8-Lead SO
42799	OP284FS	ADI	Precision Rail-to-Rail Input & Output Operational Amplifiers	8-Pin Plastic SOP
33440	OP290GP	ADI	Precision, Low Power, Micropower Dual Operational Amplifier	8- Plastic DIP
42923	OP293FS	ADI	Precision, MicropowerOperational Amplifiers	8P/SOIC
33445	OP295GS	ADI	Dual/Quad Rail-to-Rail Operational Amplifiers	8-Pin SOIC
33452	OP297GP	ADI	Dual Low Bias Current Precision Operational Amplifier	8-Pin Plastic DIP
49514	OP297GS	ADI	Dual Low Bias Current Precision Operational Amplifier	8-Pin SO
1126	OP37GP	ADI	Low-Noise Precision operational amplifier	8P/DIP
33457	OP400FY	ADI	Quad Low-Offset, Low-Power Operational Amplifier	CerDIP 14-Lead
18635	OP400GP	ADI	Quad Low Offset, Low Power Operational Amplifier	14P/DIP
33458	OP42FZ	ADI	HIGH SPEED FAST SETTTLING PRECISION Operational Amplifier	CERDIP 8-PIN
33459	OP467GP	ADI	Quad Precision, High Speed Operational Amplifier	14-Lead Plastic DIP
23224	OP470GP	ADI	Very Low Noise Quad Operational Amplifier	16P/DIP
18410	OP470GS	ADI	Very Low Noise Quad Operational Amplifier	16P/SOIC
33461	OP482GP	ADI	Dual/Quad Low Power, High Speed JFET Operational Amplifiers	14-Pin Plastic DIP
33463	OP484FP	ADI	Precision Rail-to-Rail Input & Output Operational Amplifiers	14-Pin Plastic DIP
42798	OP484FS	ADI	Precision Rail-to-Rail Input & Output Operational Amplifiers	14-Pin Plastic SOP
33469	OP490GP	ADI	Low Voltage Micropower Quad Operational Amplifier	14-Pin Plastic DIP
33470	OP491GP	ADI	Micropower Single-Supply Rail-to-Rail Input/Output Op Amps	14-Pin Plastic DIP
33472	OP491GS	ADI	Micropower Single-Supply Rail-to-Rail Input/Output Op Amps	14-Pin SOIC
33473	OP495GP	ADI	Dual/Quad Rail-to-Rail Operational Amplifiers	14-Pin Plastic DIP
33624	OP90GP	ADI	Precision,Low Voltage Micropower Operational Amplifier	plastic 8-p
41049	OP97FP	ADI	Low Power, High Precision Operational Amplifier	8P/DIP
27128	OP97FPZ	ADI	Low Power, High Precision Operational Amplifier	8P/DIP
33627	OP97FS	ADI	Low Power,High Precision Operational Amplifier	8P/DIP
27008	OPA111AM	BB	OPERATIONAL AMPLIFIER	TO-99
48475	OPA121KP	BB	OP 放大器 IC	DIP-8P
37489	OPA128LM	BB	Difet Electrometer-Grade OPERATIONAL AMPLIFIER	TO-99
40681	OPA131PA	BB	General-Purpose FET-INPUT OPERATIONAL AMPLIFIERS	DIP/8P
33631	OPA132UA	BB	High-Speed FET-INPUT OPERATIONAL AMPLIFIERS	8D/SOIC
33632	OPA134PA	BB	High Performance AUDIO OPERATIONAL AMPLIFIERS	8p/dip
33633	OPA134UA	BB	High Performanc AUDIO OPERATIONAL AMPLIFIERS	8P/DIP
33634	OPA177GP	BB	Precision OPERATIONAL AMPLIFIER	8P/DIP
33637	OPA177GS	BB	Precision OPERATIONAL AMPLIFIER	8-SO
12467	OPA177GS	BB	Precision Op-Amp.	8P/SOIC
33639	OPA2132PA	BB	HIGH-SPEED FET-INPUT OPERATIONAL AMPLIFIERS	8P/DIP
33641	OPA2132UA	BB	HIGH-SPEED FET-INPUT OPERATIONAL AMPLIFIERS	8P/DIP
33805	OPA2134PA	BB	AUDIO OPERATIONAL AMPLIFIERS	8P/DIP
33806	OPA2134UA	BB	AUDIO OPERATIONAL AMPLIFIERS	8-SO
33807	OPA2277PA	BB	High Precision OPERATIONAL AMPLIFIERS	8P/DIP
40229	OPA2277UA	BB	High Precision OPERATIONAL AMPLIFIERS	8P/SOP
45728	OPA2340PA	BB	OP 放大器 IC	8P/DIP
33809	OPA241PA	BB	Single-Supply, MicroPOWER OPERATIONAL AMPLIFIERS	8-Pin DIP
33812	OPA2604AP	BB	Dual FET-Input, Low Distortion OPERATIONAL AMPLIFIER	8-Pin Plastic DIP
33814	OPA2658U	BB	Dual Wideband, Low Power, Current Feedback OPERATIONAL AMPLIFIER	SO-8 Surface Mount
33817	OPA277PA	BB	High Precision OPERATIONAL AMPLIFIERS	8-Pin DIP
40127	OPA277U	BB	High Precision OPERATIONAL AMPLIFIERS	8P/SOIC





OP 放大器 IC

详细产品规格 - 请点击 cn.100y.com.tw

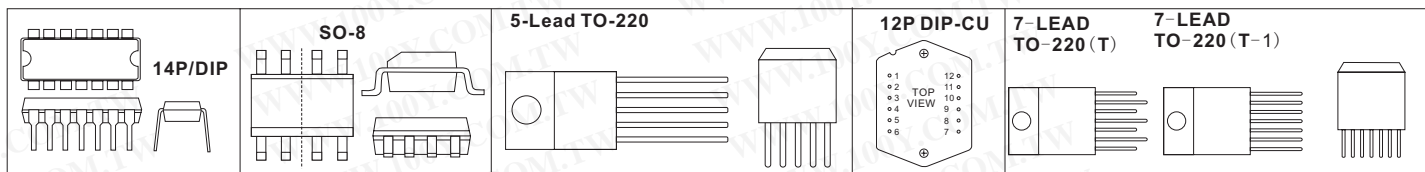

100Y 编号	厂商编号	制造厂商	说明	Pins/Package
12322	OPA27GP	BB	Ultra-Low Noise Precision OP	8P/DIP
33821	OPA27GU	BB	Ultra-Low Noise Precision OPERATIONAL AMPLIFIERS	8P/SOIC
16071	OPA37GP	BB	Ultra-Low Noise Precision OPERATIONAL AMPLIFIER	8P/DIP
33824	OPA404KP	BB	Quad High-Speed Precision Difet® OPERATIONAL AMPLIFIER	14-Pin Plastic DIP
33826	OPA4131PA	BB	General Purpose FET-INPUT OPERATIONAL AMPLIFIERS	14-Pin Plastic DIP
33828	OPA4132UA	BB	High Speed FET-INPUT OPERATIONAL AMPLIFIERS	SO-14
39251	OPA4340UA	BB	SINGLE-SUPPLY, RAIL-TO-RAIL OPERATIONAL AMPLIFIERS	16/SSOP
33831	OPA445AP	BB	High Voltage FET-Input OPERATIONAL AMPLIFIER	8-Pin DIP
28185	OPA512BM	BB	Very-High Current? High Power OPERATIONAL AMPLIFIER	8P/TO-3
47587	OPA541AP	BB	OP 放大器 IC	ZIP
47586	OPA541SM	BB	OP 放大器 IC	TO-8
33837	OPA544T	BB	High-Voltage, High-Current OPERATIONAL AMPLIFIER	5-Lead TO-220
16744	OPA548T	BB	High-Voltage, High-Current OPERATIONAL AMPLIFIER	7P/TO-220
39904	OPA549S	BB	High-Voltage, High-Current OPERATIONAL AMPLIFIER	
39242	OPA569AIDWP	BB	Rail-to-Rail I/O, 2A POWER AMPLIFIER	SO-20
34095	OPA602AP	BB	High-Speed Precision Difet® OPERATIONAL AMPLIFIER	8P/DIP
34098	OPA602AU	BB	High-Speed Precision Difet® OPERATIONAL AMPLIFIER	8P/DIP
34100	OPA604AP	BB	FET-Input, Low Distortion OPERATIONAL AMPLIFIER	8P/DIP
34103	OPA604AU	BB	FET-Input, Low Distortion OPERATIONAL AMPLIFIER	8-SO
34105	OPA620KP	BB	Wideband Precision OPERATIONAL AMPLIFIER	8P/DIP
34107	OPA620KU	BB	Wideband Precision OPERATIONAL AMPLIFIER	8-SO
16402	OPA627AP	BB	OP AMP.	8P/DIP
19483	OPA627AU	BB	OPERATIONAL AMPLIFIERS	8P/SOIC
20172	OPA627BP	BB	OPERATIONAL AMPLIFIERS	8P/DIP
34312	OPA633KP	BB	High Speed BUFFER AMPLIFIER	8-Pin Plastic DIP
34316	OPA637AP	BB	Precision High-Speed Difet® OPERATIONAL AMPLIFIERS	8P/DIP
44660	OPA640U	BB	OP 放大器 IC	8P/SOIC
34317	OPA642P	BB	Wideband, Low Distortion, Low Gain OPERATIONAL AMPLIFIER	8P/DIP
48133	OPA642U	BB	Wideband, Low Distortion, Low Gain OPERATIONAL AMPLIFIER	SO-8P
34318	OPA655P	BB	Wideband, Unity Gain Stable, FET-Input OPERATIONAL AMPLIFIER	8P/DIP
34320	OPA658P	BB	Wideband, Low Power Current Feedback OPERATIONAL AMPLIFIER	8P/DIP
40348	OPA671AP	BB	Wide Bandwidth, Fast Settling Difet OPERATIONAL AMPLIFIER	8P/DIP
34389	OPT301M	BB	INTEGRATED PHOTODIODE AND AMPLIFIER	8-Pin TO-99
19809	PA01	APEX	功率放大器	8P-TO-3
19813	PA02	APEX	功率放大器	8P TO-3
19814	PA02A	APEX	功率放大器	8P TO-3
19815	PA02M/883	APEX	功率放大器	8P TO-3
19816	PA03	APEX	功率放大器	12P DIP-CU
19817	PA03A	APEX	功率放大器	12P DIP-CU
19596	PA04	APEX	功率放大器	12P/DIP-CR
19818	PA04A	APEX	功率放大器	12P/DIP-CR
19819	PA05	APEX	功率放大器	12P DIP-CR
19820	PA05A	APEX	功率放大器	12P DIP-CR
19821	PA07	APEX	FET 输入功率放大器	8P TO-3
19822	PA07A	APEX	FET 输入功率放大器	8P TO-3
19823	PA07M/883	APEX	FET 输入功率放大器	8P TO-3
19824	PA08	APEX	功率放大器	8P TO-3-CE
19827	PA08A	APEX	功率放大器	8P TO-3-CE
19829	PA08M/883	APEX	功率放大器	8P TO-3-CE
19828	PA08V	APEX	功率放大器	8P TO-3-CE
19830	PA09	APEX	视频功率放大器	8P TO-3-CE
19831	PA09A	APEX	视频功率放大器	8P TO-3-CE
19832	PA09M/883	APEX	视频功率放大器	8P TO-3-CE
19852	PA10	APEX	Power OP Amp.	8P TO-3-CE
19853	PA10A	APEX	Power OP Amp.	8P TO-3-CE
19854	PA10M/883	APEX	Power OP Amp.	8P TO-3-CE
19855	PA12	APEX	Power OP Amp.	8P TO-3-CE
19856	PA12A	APEX	Power OP Amp.	8P TO-3-CE
19857	PA12H	APEX	Power OP Amp.	8P TO-3-CE
19858	PA12M/883	APEX	Power OP Amp.	8P TO-3-CE
19859	PA13	APEX	Power OP Amp.	12P SIP-DP
19860	PA13A	APEX	Power OP Amp.	12P SIP-DP
19937	PA140CC	APEX	High Volt. Power OP Amp.	7P DDPak



服务专线: 台湾: 886-3-5753170

传 真: 台湾: 886-3-5753172

E-mail: 台湾: sale@100y.com.tw

深圳: 86-755-83298787

深圳: 86-755-83640655

深圳: 100y@163.com

上海: 86-21-34970699

上海: 86-21-64605107

上海: 100y-1@163.com

放大器IC

OP 放大器 IC

详细产品规格 - 请点击 cn.100y.com.tw

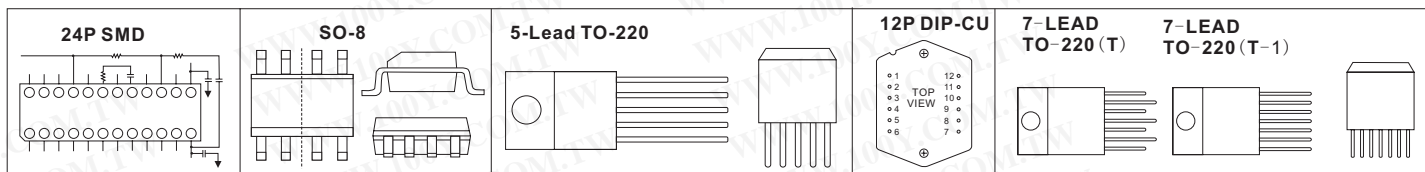

100Y 编号	厂商编号	制造厂商	说明	Pins/Package
19938	PA140CD	APEX	High Volt. Power OP Amp.	7P TO-220
19939	PA140CX	APEX	High Volt. Power OP Amp.	7P TO-220/Staggered Lead
19595	PA141	APEX	高压型功率放大器	8P/TO3-CE
19940	PA141A	APEX	高压型功率放大器	8P/TO3-CE
19941	PA141M	APEX	高压型功率放大器	8P TO-3-CE
19942	PA142	APEX	High Volt. Power OP Amp.	10P SIP-DW
19943	PA144	APEX	High Volt. Power OP Amp.	24P SMD
19861	PA15	APEX	High Volt. Power OP Amp.	10P SIP-DN
19862	PA15A	APEX	High Volt. Power OP Amp.	10P SIP-DN
19863	PA16	APEX	Power OP Amp.	12P-SIP
19864	PA16A	APEX	Power OP Amp.	12P-SIP
11399	PA21	APEX	功率 OP 双运算放大器	8P/TO-3
24608	PA21-Used	APEX	功率 OP 双运算放大器(中古)	8P/TO-3
44048	PA241DF	APEX	OP 放大器 IC	PSOP-24P
40887	PA241DW	APEX	OP 放大器 IC	10P/SIP
19867	PA33	APEX	Power OP Amp.	12P-DIP04
19868	PA50	APEX	Power OP Amp.	12P DIP-CR
19869	PA50A	APEX	Power OP Amp.	12P DIP-CR
19870	PA51	APEX	Power OP Amp.	8P TO-3-CE
19871	PA51A	APEX	Power OP Amp.	8P TO-3-CE
19873	PA51M-1/883	APEX	Power OP Amp.	8P TO-3-CE
19872	PA51M/883	APEX	Power OP Amp.	8P TO-3-CE
19833	PA52	APEX	功率放大器	12P DIP-CR
19834	PA52A	APEX	功率放大器	12P DIP-CR
19907	PA60DK	APEX	High Volt. Power OP Amp.	12P SIP-DX
19908	PA60DX	APEX	High Volt. Power OP Amp.	20P PSOP-DK
19835	PA61	APEX	功率放大器	8P TO-3-CE
19836	PA61A	APEX	功率放大器	8P TO-3-CE
19837	PA61M/883	APEX	功率放大器	8P TO-3-CE
19910	PA62DK	APEX	High Volt. Power OP Amp.	20P PSOP-DK
19838	PA73	APEX	功率放大器	8P-TO-3
19839	PA73M/883	APEX	功率放大器	8P-TO-3
19911	PA74	APEX	Power Dual OP Amp.	8P TO-3-CE
19912	PA74A	APEX	Power Dual OP Amp.	8P TO-3-CE
19914	PA75CC	APEX	Dual Power OP Amp.	7P DDPak
19915	PA75CD	APEX	Dual Power OP Amp.	7P TO-220
19916	PA75CX	APEX	Dual Power OP Amp.	7P TO-220-Staggered Lead
19935	PA76	APEX	Power Dual OP Amp.	8P TO-3-CE
19936	PA76A	APEX	Power Dual OP Amp.	8P TO-3-CE
19840	PA81J	APEX	高压型功率放大器	8P TO-3-CE
19841	PA82J	APEX	高压型功率放大器	8P TO-3-CE
19842	PA83	APEX	高压型功率放大器	8P TO-3-CE
19843	PA83A	APEX	高压型功率放大器	8P TO-3-CE
19844	PA83M/883	APEX	高压型功率放大器	8P TO-3-CE
19845	PA84	APEX	Power OP Amp.	8P TO-3-CE
19846	PA84A	APEX	Power OP Amp.	8P TO-3-CE
19848	PA84M/883	APEX	Power OP Amp.	8P TO-3-CE
19847	PA84S	APEX	Power OP Amp.	8P TO-3-CE
19849	PA85	APEX	High Volt. Power OP Amp.	8P TO-3-CE
19850	PA85A	APEX	High Volt. Power OP Amp.	8P TO-3-CE
19851	PA85M	APEX	High Volt. Power OP Amp.	8P TO-3-CE
19594	PA88	APEX	高压型功率放大器	8P/TO3-CE
19874	PA88A	APEX	高压型功率放大器	8P/TO3-CE
19875	PA88M	APEX	高压型功率放大器	8P/TO3-CE
19876	PA89	APEX	High Volt. Power OP Amp.	12P DIP-DC
19877	PA89A	APEX	High Volt. Power OP Amp.	12P DIP-DC
19878	PA90	APEX	High Volt. Power OP Amp.	12P SIP-DP
19879	PA91	APEX	High Volt. Power OP Amp.	12P SIP-DP
19880	PA92	APEX	High Volt. Power OP Amp.	12P SIP-DP
19597	PA93	APEX	高压型功率放大器	12P SIP-DP
19881	PA94	APEX	High Volt. Power OP Amp.	8P SIP-DQ
19882	PA95	APEX	High Volt. Power OP Amp.	8P SIP-DQ
19883	PA97	APEX	High Volt. Power OP Amp.	7P SIP-DR



服务专线: 台湾: 886-3-5753170

传 真: 台湾: 886-3-5753172

E-mail: 台湾: sale@100y.com.tw

深圳: 86-755-83298787

深圳: 86-755-83640655

深圳: 100y@163.com

上海: 86-21-34970699

上海: 86-21-64605107

上海: 100y-1@163.com



OP 放大器 IC

详细产品规格 - 请点击 cn.100y.com.tw

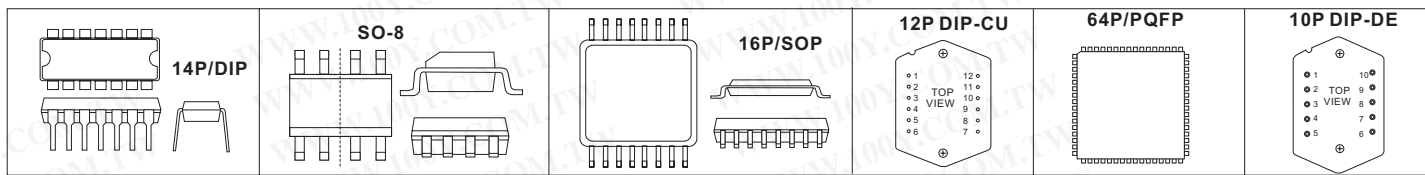

100Y 编号	厂商编号	制造厂商	说明	Pins/Package
19885	PA98	APEX	Power OP Amp.	12P SIP-DP
19884	PA98A	APEX	Power OP Amp.	12P SIP-DP
19886	PB50	APEX	POWER BOOSTER AMPLIFIERS	8P TO-3
19887	PB51	APEX	Power OP Amp.	12P SIP-DP
19888	PB51A	APEX	Power OP Amp.	12P SIP-DP
19889	PB58	APEX	POWER BOOSTER AMPLIFIERS	8P TO-3
19598	PB58A	APEX	POWER BOOSTER AMPLIFIERS	8P TO-3
48594	RC4558P	T.I.	DUAL GENERAL-PURPOSE OPERATIONAL AMPLIFIERS	8P/SOIC
40107	S494		Pulse Width Modulation	SOP-16
39454	S494P		Pulse Width Modulation	DIP-16
19891	SA01	APEX	Pulse Width Modulation Amp.	10P DIP-DE
19890	SA03	APEX	Pulse Width Modulation Amp.	12P DIP-CR
19892	SA04	APEX	Pulse Width Modulation Amp.	12P DIP-CR
19896	SA06	APEX	Pulse Width Modulation Amp.	12P DIP-DD
19897	SA07	APEX	Pulse Width Modulation Amp.	18P DIP-EL
19898	SA08	APEX	Pulse Width Modulation Amp.	12P DIP-CR
19899	SA12	APEX	Pulse Width Modulation Amp.	12P DIP-CR
19900	SA13	APEX	Pulse Width Modulation Amp.	12P DIP-CR
19901	SA14	APEX	Pulse Width Modulation Amp.	12P DIP-CR
19902	SA16	APEX	Pulse Width Modulation Amp.	12P DIP-DD
19903	SA18	APEX	Pulse Width Modulation Amp.	12P DIP-CR
34809	SA601DK	PHILIPS	Low voltage LNA and mixer - 1GHz	20P/DIP
34815	SAA7111AH	PHILIPS	Enhanced Video Input Processor	64P/PQFP
19362	SAA7111AHZ	PHILIPS	Enhanced Video Input Processor (EVIP)	64P/PQFP
41708	TA8406F	TOSHIBA	DUAL POWER OPERATIONAL AMPLIFIER	HSOP/16P
37393	TCA0372DP1	ON-Semi.	Dual Power Operational Amplifier	8P/DIP
33680	THS3001CD	T.I.	420-MHz HIGH-SPEED CURRENT-FEEDBACK AMPLIFIERS	8P/SOIC
33676	THS4031CD	T.I.	100-MHz LOW-NOISE HIGH-SPEED AMPLIFIERS	8P/SOIC
33672	THS4061CD	T.I.	180-MHz HIGH-SPEED AMPLIFIERS	8P/SOIC
3973	TL022CP	T.I.	DUAL LOW-POWER GENERAL-PURPOSE OPERATIONAL AMPLIFIER	8P/DIP
33448	TL031CP	T.I.	ENHANCED-JFET LOW-POWER LOW-OFFSET OPERATIONAL AMPLIFIERS	8P/DIP
33450	TL032CD	T.I.	ENHANCED-JFET LOW-POWER LOW-OFFSET OPERATIONAL AMPLIFIERS	8P/SOIC
42814	TL032CP	T.I.	ENHANCED-JFET LOW-POWER LOW-OFFSET OPERATIONAL AMPLIFIERS	DIP-8
33446	TL034CD	T.I.	ENHANCED-JFET LOW-POWER LOW-OFFSET OPERATIONAL AMPLIFIERS	14P/SOIC
33444	TL061CD	T.I.	LOW-POWER JFET-INPUT GENERAL-PURPOSE OPERATIONAL AMPLIFIER	8P/SOIC
22849	TL061CN	T.I.	LOW POWER SINGLE J-FET OPERATIONAL AMPLIFIERS	8P/DIP
1131	TL061CP	T.I.	LOW-POWER JFET-INPUT GENERAL-PURPOSE OPERATIONAL AMPLIFIER	8P/DIP
22850	TL062CDR	T.I.	LOW-POWER JFET-INPUT OPERATIONAL AMPLIFIERS	8P/DIP
1132	TL062CP	T.I.	Low power LFET input operational amplifier	8P/DIP
33442	TL064CD	T.I.	Low power LFET input operational amplifier	14P/SOIC
1133	TL064CN	T.I.	Low power LFET input operational amplifier	14P/DIP
33438	TL071ACP	T.I.	Low noise, LFET input operational amplifier	8P/DIP
1359	TL071CD	T.I.	Low noise, LFET input operational amplifier	8P/SOIC
33435	TL071CN	ST(SGS)	Low noise, LFET input operational amplifier	8P/DIP
1134	TL071CP	T.I.	LOW-NOISE JFET-INPUT GENERAL-PURPOSE OPERATIONAL AMPLIFIER	8P/DIP
33433	TL072ACP	T.I.	Low Noise, JFET Input Operational Amplifier	8P/DIP
1360	TL072CD	T.I.	Low Noise, JFET Input Operational Amplifier	8P/SOIC
19300	TL072CN	ST(SGS)	LOW NOISE J-FET DUAL OPERATIONAL AMPLIFIERS	8P/DIP
1135	TL072CP	T.I.	DUAL LOW-NOISE JFET-INPUT GENERAL-PURPOSE OPERATIONAL AMPLIFIER	8P/DIP
33431	TL074ACN	T.I.	Low Noise, JFET Input Operational Amplifier	14P/DIP
46065	TL074CD	T.I.	Quad Low-Noise JFET-Input General-Purpose Operational Amplifier	14P/SOIC
10021	TL074CD	ST(SGS)	Low noise JFET quad op amp.	14P/SOIC
29277	TL074CN	T.I.	Low Noise, JFET Input Operational Amplifier	14P/DIP
1136	TL074CN	ST(SGS)	Low Noise, JFET Input Operational Amplifier	14P/DIP
33430	TL074ID	T.I.	Low Noise, JFET Input Operational Amplifier	14P/SOIC
33416	TL081CN	ST(SGS)	GENERAL PURPOSE J-FET SINGLE OPERATIONAL AMPLIFIER	8P/DIP
1137	TL081CP	T.I.	JFET-INPUT GENERAL-PURPOSE OPERATIONAL AMPLIFIER	8P/DIP
33231	TL082ACP	T.I.	JFET-INPUT OPERATIONAL AMPLIFIERS	8P/DIP
32202	TL082C	ST(SGS)	General Purpose Dual JFET OP-Amp	8P/SOIC
1376	TL082CD	T.I.	JFET input dual Operational Amplifier	8P/SOIC
33233	TL082CN	T.I.	JFET-INPUT OPERATIONAL AMPLIFIERS	8P/PDIP
1138	TL082CN	ST(SGS)	General Purpose Dual JFET OP-Amp	8P/DIP
19301	TL082CP	T.I.	JFET-INPUT OPERATIONAL AMPLIFIERS	8P/DIP





OP 放大器 IC

详细产品规格 - 请点击 cn.100y.com.tw

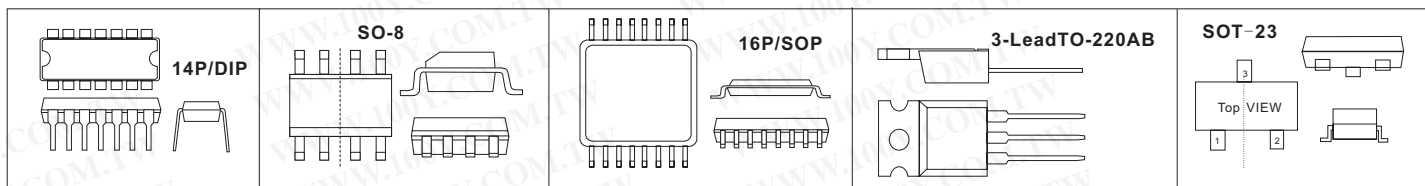

100Y 编号	厂商编号	制造厂商	说明	Pins/Package
1363	TL084ACD	T.I.	6mW QUAD JFET OP-AMPS	14P/SOIC(0~70°C)
41324	TL084ACN	ST(SGS)	JFET-INPUT OPERATIONAL AMPLIFIERS	14P/DIP
33235	TL084ACN	T.I.	JFET-INPUT OPERATIONAL AMPLIFIERS	14P/DIP
40408	TL084CDR	ST(SGS)	GENERAL PURPOSE JFET QUAD OP-AMPS	14P/SOIC
27905	TL084CDR	T.I.	15mW OP 放大器 IC	14P/SOIC(0~70°C)
1139	TL084CN	ST(SGS)	15mW JFET Input Operational Amplifier	14P/DIP(0~70°C)
40822	TL084ID	T.I.	JFET-INPUT OPERATIONAL AMPLIFIER	14P/SOIC
13028	TL783CKC	T.I.	HIGH-VOLTAGE ADJUSTABLE REGULATOR	TO/220AB
18432	TLC2252CP	T.I.	Advanced LinCMOS RAIL-TO-RAIL VERY LOW-POWER OPERATIONAL AMPLIFIERSAdvanced LinCMOS? RAIL-TO-RAIL VERY LOW-POWER OPERATIONAL AMPLIFIERS	8P/DIP
16427	TLC2254CN	T.I.	VERY LOW-POWER OPERATIONAL AMPLIFIERS	14P/DIP
18433	TLC2262CP	T.I.	DUAL ADVANCED LINCOS(TM) RAIL-TO-RAIL OPERATIONAL AMPLIFIER	8P/DIP
41501	TLC2272CDR	T.I.	TLC2272CDR 放大器 IC	SOIC-8P
18435	TLC2272CP	T.I.	DUAL ADVANCED LINCOS(TM) RAIL-TO-RAIL OPERATIONAL AMPLIFIER	8P/DIP
33284	TLC2272ID	T.I.	Advanced LinCMOSE RAIL-TO-RAIL OPERATIONAL AMPLIFIERS	8P/SOIC
39647	TLC2274CD	T.I.	OPERATIONAL AMPLIFIERS	14P-SO
16429	TLC2274CN	T.I.	OPERATIONAL AMPLIFIERS	14P/DIP
33283	TLC2274ID	T.I.	Advanced LinCMOSE RAIL-TO-RAIL OPERATIONAL AMPLIFIERS	14P/SOIC
33291	TLC252CP	T.I.	LinCMOSE DUAL OPERATIONAL AMPLIFIERS	8P/DIP
13162	TLC2652AC-8D	T.I.	Volt. Feedback BICMOS OP Amp(Single)	8P/SOP
18436	TLC2654CP	T.I.	Advanced LinCMOS LOW-NOISE CHOPPER-STABILIZED OPERATIONAL AMPLIFIERS	8P/DIP
44926	TLC2654IP	T.I.	Low-Noise Chopper-Stabilized Operational Amplifier	8P/DIP
33295	TLC271ACP	T.I.	LinCMOSE PROGRAMMABLE LOW-POWER OPERATIONAL AMPLIFIERS	8P/DIP
33296	TLC271CD	T.I.	LinCMOSE PROGRAMMABLE LOW-POWER OPERATIONAL	8P/SOIC
33298	TLC271CP	T.I.	LinCMOSE PROGRAMMABLE LOW-POWER OPERATIONAL	8P/DIP
33299	TLC271ID	T.I.	LinCMOSE PROGRAMMABLE LOW-POWER OPERATIONAL	8P/SOIC
16442	TLC271IP	T.I.	PROGAMMABLE LOW-POWER OPERATIONAL AMPLIFIERS	8P/DIP
19304	TLC272CDR	T.I.	DUAL OPERATIONAL AMP.	8P-SOIC
16163	TLC272CP	T.I.	OP Amp	8P/DIP
33300	TLC274ACD	T.I.	LinCMOSE PRECISION QUAD OPERATIONAL AMPLIFIERS	14P/SOIC
33302	TLC274CD	T.I.	LinCMOSE PRECISION QUAD OPERATIONAL AMPLIFIERS	14P/SOIC
19305	TLC274CDR	T.I.	放大器 IC	SOP
33304	TLC277CP	T.I.	LinCMOSE PRECISION DUAL OPERATIONAL AMPLIFIERS	8P/DIP
16439	TLC27L2CP	T.I.	PRECISION DUAL OPERATIONAL AMPLIFIERS	8P/DIP
16574	TLC27L4CN	T.I.	OP Amp	14P/DIP
33306	TLC27M2CP	T.I.	LinCMOSE PRECISION DUAL OPERATIONAL AMPLIFIERS	8P/DIP
33309	TLC27M4CD	T.I.	LinCMOSE PRECISION QUAD OPERATIONAL AMPLIFIERS	14P/SOIC
19367	TLC3704CN	T.I.	QUAD MICROPOWER LinCMOS TM VOLTAGE COMPARATORS	14P/DIP
33353	TLC4502ID	T.I.	FAMILY OF SELF-CALIBRATING Self-CalE PRECISION CMOS RAIL-TO-RAIL OUTPUT OPERATIONAL AMPLIFIERS	8P/SOIC
13337	TLE2022CP	T.I.	EXCALIBUR HIGH-SPEED LOW-POWER PRECISION OPERATIONAL AMPLIFIERS	8P/DIP
16159	TLE2064CN	T.I.	OPERATIONAL AMPLIFIERS	14P/DIP
33391	TLE2071CP	T.I.	EXCALIBUR LOW-NOISE HIGH-SPEED JFET-INPUT OPERATIONAL AMPLIFIERS	8P/DIP
33394	TLE2071IP	T.I.	EXCALIBUR LOW-NOISE HIGH-SPEED JFET-INPUT OPERATIONAL AMPLIFIERS	8P/DIP
33395	TLE2072CP	T.I.	EXCALIBUR LOW-NOISE HIGH-SPEED JFET-INPUT OPERATIONAL AMPLIFIERS	8P/DIP
33398	TLE2074CN	T.I.	EXCALIBUR LOW-NOISE HIGH-SPEED JFET-INPUT OPERATIONAL AMPLIFIERS	14P/DIP
33401	TLE2074IDW	T.I.	EXCALIBUR LOW-NOISE HIGH-SPEED JFET-INPUT OPERATIONAL AMPLIFIERS	16P/SOIC
33403	TLE2074IN	T.I.	EXCALIBUR LOW-NOISE HIGH-SPEED JFET-INPUT OPERATIONAL AMPLIFIERS	14P/DIP
33405	TLE2141ACD	T.I.	EXCALIBUR LOW-NOISE HIGH-SPEED JFET-INPUT OPERATIONAL AMPLIFIERS	8P/SOIC
33404	TLE2141CP	T.I.	EXCALIBUR LOW-NOISE HIGH-SPEED JFET-INPUT OPERATIONAL AMPLIFIERS	8P/DIP
33407	TLE2144CN	T.I.	EXCALIBUR LOW-NOISE HIGH-SPEED JFET-INPUT OPERATIONAL AMPLIFIERS	14P/DIP
41503	TLV2231CDBV	T.I.	TLV2231CDBV OP 放大器 IC	SOT-23
32968	TLV2252ID	T.I.	Advanced LinCMOSE RAIL-TO-RAIL VERY LOW-POWER OPERATIONAL AMPLIFIERS	14P SMD
32966	TLV2462CP	T.I.	FAMILY OF LOW-POWER RAIL-TO-RAIL INPUT/OUTPUT OPERATIONAL AMPLIFIERS WITH SHUTDOWN	8P/DIP
32965	TLV274CD	T.I.	550-UA/CH 3-MHZ RAIL TO RAIL OUTPUT OPERATIONAL AMPLIFIERS	14P SMD
41711	TS272CDT	ST(SGS)	ST_High Speed CMOS Dual OP Amp	SO8
29407	TS272CN	ST(SGS)	ST_High Speed CMOS Dual OP Amp	8P/DIP
32687	UA741CD	T.I.	General-Purpose single OP-amps	SO8
36218	UA741CN	ST(SGS)	General-Purpose single OP-amps	8P/DIP
32691	UA741CP	ST(SGS)	General-Purpose single OP-amps	
4866	UA747CN	T.I.	Dual operational amplifier	14P/DIP
25773	UC3903		op-amp	18P/DIP





放大器IC

OP 放大器 IC

详细产品规格 - 请点击 cn.100y.com.tw

100Y 编号	厂商编号	制造厂商	说明	Pins/Package
23804	UPC324C	NEC	LOW POWER QUAD OPERATIONAL AMPLIFIER	14P/DIP
23751	UPC358C	NEC	DUAL OPERATIONAL AMPLIFIER	8P/DIP
43353	UPC458C	NEC	Bipolar Analog Integrated Circuit	DIP-14P

Sample and Hold Amp. Sample and Hold Amplifiers

详细产品规格 - 请点击 cn.100y.com.tw

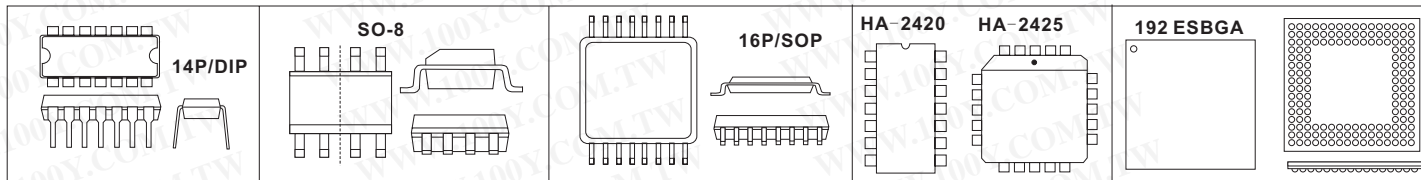

100Y 编号	厂商编号	制造厂商	说明	Pins/Package
32324	AD585AQ	ADI	High Speed, Precision Sample-and-Hold Amplifier	14-Pin DIP
32391	AD684JQ	ADI	Four-Channel Sample-and-Hold Amplifier	16P/DIP
48746	AD781ANZ	ADI	Complete 700 ns Sample-and-Hold Amplifier	DIP
32543	AD781JN	ADI	Complete 700 ns Sample-and-Hold Amplifier	8P/DIP
32548	AD783JQ	ADI	Complete Very High Speed Sample-and-Hold Amplifier	8P/DIP
44798	HA4P2425-5	Intersil	放大器 IC	20P/PLCC
22636	J111	Fairchild	N-Channel Switch	3P/TO-92
18511	LF398H	N.S	Monolithic Sample-and-Hold Circuits	8P/TO-5
47341	LF398M	N.S	Monolithic Sample and Hold Circuit	SMD-14P
3829	LF398N	N.S	Monolithic Sample and Hold Circuit	8P/DIP
34893	MAX106CHC	MAXIM	±5V, 600Msps, 8-Bit ADC with On-Chip 2.2GHz Bandwidth Track/Hold Amplifier	192 ESBGA
35097	SMP04EP	ADI	Sample-and-Hold Amplifier	16P/DIP

测量仪表用放大器IC 测量仪表用放大器IC

详细产品规格 - 请点击 cn.100y.com.tw

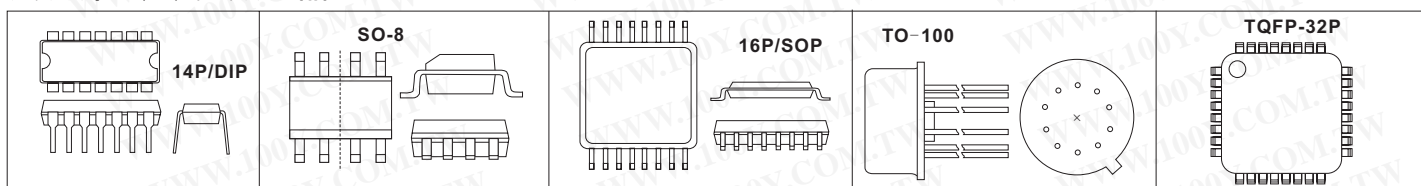

100Y 编号	厂商编号	制造厂商	说明	Pins/Package
28256	AD524AD	ADI	instrumentation OP Amp.	16/DIP
32265	AD524AR-16	ADI	Precision Instrumentation Amplifier	16P/SOIC
32267	AD524BD	ADI	Precision Instrumentation Amplifier	16P/DIP
23701	AD526JN	ADI	instrumentation OP Amp.	16P/DIP
32277	AD534JD	ADI	Internally Trimmed Precision IC Multiplier	14P/DIP
32278	AD534JH	ADI	Internally Trimmed Precision IC Multiplier	10P/TO-100
16431	AD620ANZ	ADI	Low Cost, Low Power, Instrumentation Amplifier	8P/DIP
18638	AD620AR	ADI	Low Cost, Low Power, Instrumentation Amplifier	8P/SO
32840	AD620BN	ADI	Low Cost, Low Power, Instrumentation Amplifier	8P/DIP
19377	AD622ANZ	ADI	Instrumentation Amplifiers	8P/DIP
19378	AD623AN	ADI	Instrumentation Amplifiers	8P/DIP
22224	AD623AR	ADI	Single Supply, Rail-to-Rail, Low Cost Instrumentation Amp.	SOP-8
41151	AD623BR	ADI		
32356	AD624AD	ADI	Precision Instrumentation Amplifier	16P/DIP
32358	AD625JN	ADI	Programmable Gain Instrumentation Amplifier	16P/DIP
32360	AD627AN	ADI	Micropower, Single and Dual Supply Rail-to-Rail Instrumentation Amplifier	8P/DIP
32363	AD632AD	ADI	Internally Trimmed Precision IC Multiplier	14P/DIP
19379	AD8021AR	ADI	Low Noise, High Speed Amplifier for 16-Bit Systems	8P/SOIC
33247	AD8230YRZ	ADI	Precision Instrumentation Amplifier	8P/SOIC
32686	AMP01FX	ADI	Low Noise, Precision Instrumentation Amplifier	18-Lead Cerdip
32688	AMP02FP	ADI	High Accuracy 8-Pin Instrumentation Amplifier	8P/DIP
32692	AMP04FP	ADI	Precision Single Supply Instrumentation Amplifier	8P/DIP
32694	AMP04FS	ADI	Precision Single Supply Instrumentation Amplifier	8P/SOIC
49780	E211ATF	SEMTECH	TEST AND MEASUREMENT PRODUCTS	TQFP-32P
27802	FDS6680A	Fairchild	FAIRCHILD SEMICONDUCTOR LOGIC LEVEL MOSFETS	N-CHANNEL
18170	ICL7650CPA-1	MAXIM	Chopper-Stabilized Op Amp	8P-DIP
33611	ICL7650CSA	MAXIM	Chopper-Stabilized Op Amp	8P/SO
33653	INA101HP	T.I.	High Accuracy INSTRUMENTATION AMPLIFIER	14P/DIP
33655	INA103KP	T.I.	Low Noise, Low Distortion INSTRUMENTATION AMPLIFIER	16P/DIP





放大器IC

测量仪表用放大器IC

详细产品规格 - 请点击 cn.100y.com.tw

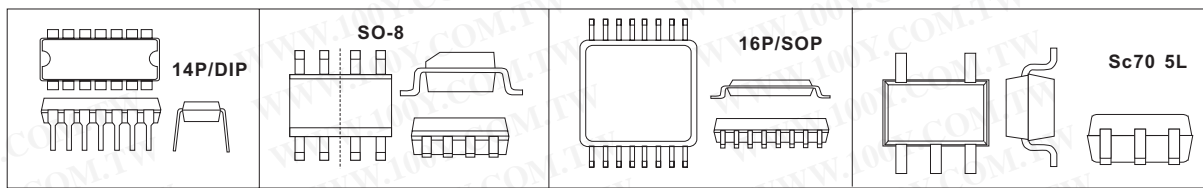

100Y 编号	厂商编号	制造厂商	说明	Pins/Package
33658	INA110KP	T.I.	Fast-Settling FET-Input INSTRUMENTATION AMPLIFIER	16P/DIP
33661	INA111AP	T.I.	High Speed FET-Input INSTRUMENTATION AMPLIFIER	8P/DIP
12466	INA114AP	BB	Precision Instrumentation Amplifier	8P/DIP
12202	INA114AU	BB	Precision Instrumentation Amplifier	16P/SOIC
12676	INA114BU	BB	Precision Instrumentation Amplifier	16P/SOIC
33662	INA115AU	T.I.	Precision INSTRUMENTATION AMPLIFIER	SOL-16
33664	INA116PA	T.I.	Ultra Low Input Bias Current INSTRUMENTATION AMPLIFIER	16P/DIP
33666	INA118P	T.I.	Precision, Low Power INSTRUMENTATION AMPLIFIER	8P/DIP
33667	INA118U	T.I.	Precision, Low Power INSTRUMENTATION AMPLIFIER	SO-8
33669	INA122PA	T.I.	Single Supply, MicroPower INSTRUMENTATION AMPLIFIER	8-Pin DIP
33670	INA122UA	T.I.	Single Supply, MicroPower INSTRUMENTATION AMPLIFIER	SO-8
33671	INA125PA	T.I.	INSTRUMENTATION AMPLIFIER With Precision Voltage Reference	16P/DIP
33673	INA126PA	T.I.	MicroPOWER INSTRUMENTATION AMPLIFIER Single and Dual Versions	8-Pin DIP
33674	INA126UA	T.I.	MicroPOWER INSTRUMENTATION AMPLIFIER Single and Dual Versions	SO-8
33675	INA128P	T.I.	Precision, Low Power INSTRUMENTATION AMPLIFIERS	8P/DIP
33323	INA128U	BB	Precision, Low Power INSTRUMENTATION AMPLIFIERS	8P/SO
16162	INA131AP	BB	Precision G=100 Instrumentation Amplifier	8P/DIP
33679	INA141U	T.I.	Precision, Low Power, G = 10, 100 INSTRUMENTATION AMPLIFIER	SO-8
7361	LM4250CN	N.S	Programmable Operational Amplifier	8P/DIP
49602	LTC1050ACN8	Linear-Tech.	Chopper-Stabilized Op Amp	8/DIP
35550	LTC1052CN	Linear-Tech.	Low Noise Chopper-Stabilized Op Amp	14P/DIP
16252	LTC1052CN8	Linear-Tech.	Low Noise Chopper-Stabilized Op Amp	8P/DIP
42560	MAX9140EUK	MAXIM	40ns, Low-Power, 3V/5V, Rail-to-Rail Single-Supply Comparators	5 SOT23-5
19639	OP05CJ	ADI	Instrumentation Operational Amplifier	8P/TO-99

Video放大器IC Video Amplifiers

详细产品规格 - 请点击 cn.100y.com.tw

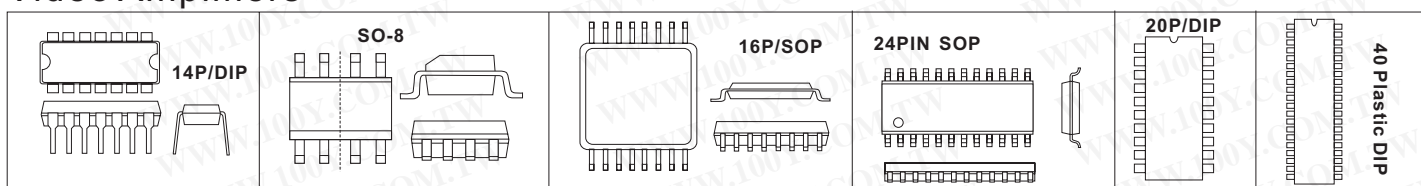

100Y 编号	厂商编号	制造厂商	说明	Pins/Package
32347	AD600JN	ADI	Dual, Low Noise, Wideband Variable Gain Amplifiers	16P/DIP
32349	AD602JN	ADI	Dual, Low Noise, Wideband Variable Gain Amplifiers	16P/DIP
32352	AD603AQ	ADI	Low Noise, 90 MHz Variable-Gain Amplifier	8P/DIP
32354	AD603AR	ADI	Low Noise, 90 MHz Variable-Gain Amplifier	8P/DIP
37538	AD604ARS	ADI	Dual, Ultralow Noise Variable Gain Amplifier	24P/SSOP
32565	AD813AR-14	ADI	Single Supply, Low Power Triple Video Amplifier	14P/SOIC
33413	AD8184	ADI	700 MHz, 5 mA 4-to-1 Video Multiplexer	14P/SOP
32597	AD9300KQ	ADI	4 *1 Wideband Video Multiplexer	16P/DIP
47609	CXA1645M	SONY	放大器 IC	SOP-24
32932	CXA1645P	SONY	RGB Encoder	24PIN DIP
33076	EL2260CN	Elantec	Dual/Quad 130 MHz Current Feedback Amplifiers	8-Pin P-DIP
41245	EL4089CN	Elantec	VIDEO AMPLIFIER	8P/DIP
41249	EL4421CN	Elantec	VIDEO AMPLIFIERS	4P/DIP
40147	EL4421CS	Elantec	Multiplexed-Input Video Amplifiers	8P/SO
41250	EL4421CS	Elantec	MULTIPLEXED-INPUT VIDEO AMPLIFIERS	8P/SO
33082	EL4581CN	Elantec	Sync Separator, 50% Slice, S-H, Filter	8-Pin DIP
33083	EL4583CN	Elantec	Sync Separator, 50% Slice, S-H, Filter, HOUT	16-Pin PDIP
40132	EL4583CS	Elantec	Sync Separator, 50% Slice, S-H, Filter, HOUT	16P/SOP
40135	EL4584CS	Elantec	Horizontal Genlock, 4FSC	16P/SO
22652	LM1207AN	N.S	130 MHz/85 MHz RGB Video Amplifier System with Blanking	28P/DIP
22653	LM1881MX	N.S	Video Sync Separator	8P/SOP
34967	MAX4137EWG	MAXIM	1-Input/4-Output Video Distribution Amplifiers	24P/SO
34970	MAX441CPP	MAXIM	High-Speed Video Multiplexer/Amplifier	20P/DIP
34971	MAX442CPA	MAXIM	140MHz, 2-Channel Video Multiplexer/Amplifier	8 Plastic DIP
34974	MAX455CPP	MAXIM	CMOS Video Multiplexer/Amplifier	20P/DIP
34975	MAX456CPL	MAXIM	8 x 8 Video Crosspoint Switch	40 Plastic DIP



服务专线: 台湾: 886-3-5753170

传 真: 台湾: 886-3-5753172

E-mail: 台湾: sale@100y.com.tw

深圳: 86-755-83298787

深圳: 86-755-83640655

深圳: 100y@163.com

上海: 86-21-34970699

上海: 86-21-64605107

上海: 100y-1@163.com

放大器IC

Video Amplifiers

详细产品规格 - 请点击 cn.100y.com.tw

100Y 编号	厂商编号	制造厂商	说明	Pins/Package
34976	MAX457CPA	MAXIM	Dual CMOS Video Amplifier	8P/DIP
34983	MAX496CPE	MAXIM	375MHz Quad Closed-Loop Video Buffers, AV = +1 and +2	16 Plastic DIP
34984	MAX497CPE	MAXIM	375MHz Quad Closed-Loop Video Buffers, AV = +1 and +2	16 Plastic DIP
35474	MPC100AP	T.I.	Wide Bandwidth 4 x 1 VIDEO MULTIPLEXER	14P/DIP
42437	NE592D8R2	ON -Semi.	Video Amplifiers	SOIC-8
22766	NE592N8	PHILIPS	Video amplifier	8P/DIP
22768	NJM2244D	JRC	3-INPUT VIDEO SWITCH DRIVER	8P/DIP
22769	NJM2246D	JRC	3-INPUT VIDEO SWITCH WITH 6dB AMPLIFIER	8P/DIP
22773	NJM592M8	JRC	VIDEO AMPLIFIER	8P/SMD
19865	PA19	APEX	Video Power OP Amp.	8P TO-3-CE
19866	PA19A	APEX	Video Power OP Amp.	8P TO-3-CE
45035	PI5V330Q		Video 放大器 IC	QSOP
19368	UA9637	T.I.	DUAL DIFFERENTIAL LINE RECEIVER	8P/DIP

隔离放大器 隔离放大器

详细产品规格 - 请点击 cn.100y.com.tw

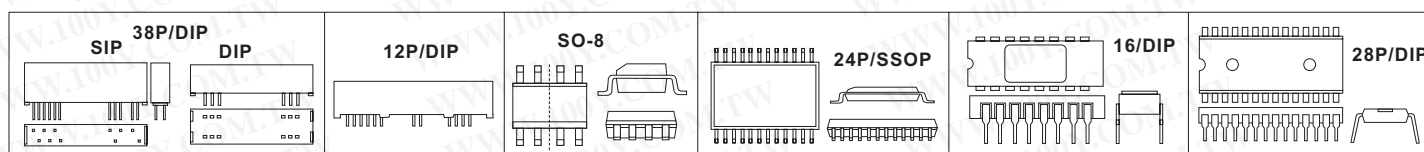

100Y 编号	厂商编号	制造厂商	说明	Pins/Package
32243	AD202JN	ADI	Low Cost Miniature Isolation Amplifiers	38P/DIP
32246	AD202JY	ADI	Low Cost Miniature Isolation Amplifiers	38P/SIP
32247	AD204JY	ADI	Low Cost Miniature Isolation Amplifiers	38P/SIP
35509	AD210AN	ADI	Precision, Wide Bandwidth	12P/DIP
32251	AD210JN	ADI	Precision, Wide Bandwidth	12P/DIP
32255	AD215AY	ADI	120 kHz Bandwidth, Low Distortion, Isolation Amplifier	44P/SIP
40230	AD8534AR	ADI	Low Cost, 250 mA Output, Single-Supply Amplifier	SOIC/14P
33305	HCPL-7800	Agilent	Isolation Amplifier	8P/DIP
33307	HCPL-7840	Agilent	Isolation Amplifier	8P/DIP
34417	ISO102	T.I.	SIGNAL ISOLATION BUFFER AMPLIFIERS	24P/DIP
40999	ISO122JP	BB	隔离放大器	16-Pin Plastic DIP
34418	ISO122P	T.I.	Precision Lowest Cost ISOLATION AMPLIFIER	16-Pin Plastic DIP
34419	ISO122U	T.I.	Precision Lowest Cost ISOLATION AMPLIFIER	28-Pin Plastic SOIC
16160	ISO124P	BB	Precision Lowest Cost Isolation Amplifier	16P/DIP
34420	ISO124U	T.I.	Precision Lowest Cost ISOLATION AMPLIFIER	28-Pin Plastic SOIC

微分放大器 微分放大器

详细产品规格 - 请点击 cn.100y.com.tw

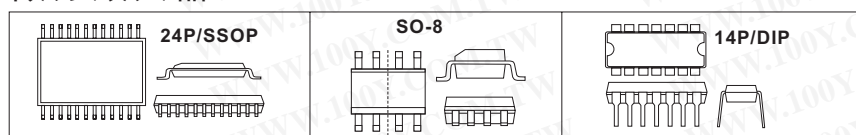

100Y 编号	厂商编号	制造厂商	说明	Pins/Package
22423	AD815ARB-24	ADI	High Output Current Differential Driver	24-Lead Thermally-Enhanced SOIC (RB-24)
32583	AD830AN	ADI	High Speed, Video Difference Amplifier	8P/DIP
32689	AMP03GP	ADI	Precision, Unity-Gain Differential Amplifier	8P/DIP
43950	CA3028A	Intersil	微分放大器	8 Pin Metal Can
37874	EL2002CN	Elantec	Low Power, 180 MHz Buffer Amplifier	8P/PDIP
37875	EL2030CN	Elantec	120MHz Current Feedback Amplifier	8P/PDIP
37876	EL2082CN	Elantec	Current-Mode Multiplier	8P/DIP
37877	EL2090CN	Elantec	100 MHz DC-Restored Video Amplifier	14P/DIP
33074	EL2140CN	Elantec	150 MHz Differential Twisted Pair Driver	8-pin PDIP
33075	EL2140CS	Elantec	150 MHz Differential Twisted Pair Driver	8-pin SOIC
43074	ERA-1SM	Mini-Circuits	MONOLITHIC AMPLIFIERS	SOT86
16161	INA105KP	BB	Precision Unity Gain Differential Amplifier	8P/DIP
33656	INA105KU	T.I.	Precision Unity Gain Differential Amplifier	8P/SOIC
15378	INA117KU	T.I.	High Common-Mode Voltage DIFFERENCE AMPLIFIER	SO-8
33677	INA132UA	T.I.	Low Power, Single-Supply DIFFERENCE AMPLIFIER	SO-8
34977	MAX471CPA	MAXIM	Precision, High-Side Current Sense Amplifier	8P/DIP
40356	MAX471CSA	MAXIM	Precision, High-Side Current Sense Amplifier	8P/SOP
22059	MAX472CPA	MAXIM	Precision, High-Side Current Sense Amplifier	8P/DIP
45067	MAX472CSA	MAXIM	Precision, High-Side Current Sense Amplifier	8P/SOIC
33402	THS4130	T.I.	HIGH SPEED LOW NOISE, FULLY DIFFERENTIAL I/O AMPLIFIERS	8P/SOP



服务专线: 台湾: 886-3-5753170

传 真: 台湾: 886-3-5753172

E-mail: 台湾: sale@100y.com.tw

深圳: 86-755-83298787

深圳: 86-755-83640655

深圳: 100y@163.com

上海: 86-21-34970699

上海: 86-21-64605107

上海: 100y-1@163.com