

### MOTIEN\_直流转直流-双组电源转换器

详细产品规格 - 请点击 [cn.100y.com.tw](http://cn.100y.com.tw)

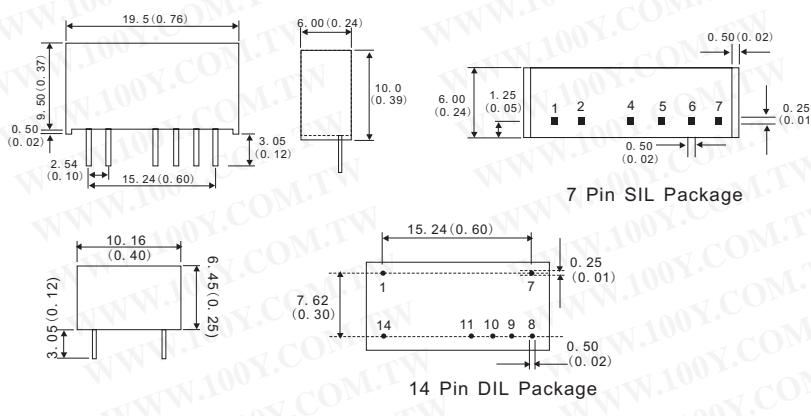

PIN NUMBER	SINGLE	DUAL	SINGLE -H	DUAL -H
1	+V Input	+V Input	+V Input	+V Input
2	-V Input	-V Input	-V Input	-V Input
4	-V output	-V output	N. P.	N. P.
5	N. P.	Common	-V output	-V output
6	+V output	+V output	N. P.	Common
7	N. P.	N. P.	+V output	+V output

PIN NUMBER	SINGLE	DUAL	SINGLE -H	DUAL -H
1	-V Input	-V Input	-V Input	-V Input
7	N. C.	N. C.	N. C.	N. C.
8	N. P.	Common	+V output	+V output
9	+V output	+V output	N. P.	Common
10	N. P.	N. P.	-V output	-V output
11	-V output	-V output	N. P.	N. P.
14	+V Input	+V Input	+V Input	+V Input

100Y 编号	厂商编号	制造厂商	说明	DCVout	Current	DCVout	Current	Watts	Efficiency %	DCVin
39977	V3-0505D	MOTIEN	DC/DC 双组电源转换器(=C&D_NMH 0505 D)	-5V	-200mA	+5V	+200mA	2W	73%	5V
39978	V3-0512D	MOTIEN	DC/DC 双组电源转换器(=C&D_NMH 0512 D)	-12V	-84mA	+12V	+84mA	2W	80%	5V
39979	V3-0515D	MOTIEN	DC/DC 双组电源转换器(=C&D_NMH 0515 D)	-15V	-67mA	+15V	+67mA	2W	82%	5V
39980	V3-1205D	MOTIEN	DC/DC 双组电源转换器(=C&D_NMH 1205 D)	-5V	-200mA	+5V	+200mA	2W	75%	12V
39982	V3-1212D	MOTIEN	DC/DC 双组电源转换器(=C&D_NMH 1212 D)	-12V	-83mA	+12V	+83mA	2W	83%	12V
39983	V3-1215D	MOTIEN	DC/DC 双组电源转换器(=C&D_NMH 1215 D)	-15V	-67mA	+15V	+67mA	2W	85%	12V
48543	V3-2415S	MOTIEN	DC/DC 双组电源转换器	-15V	-33.33mA	+15V	+33.33mA	1W	82%	24V

**特点:**

- Regulated 24 pin DIL 包装
- 低波纹和噪声
- 1000 Vdc 隔离
- Up to 5200 Vdc 隔离
- 连续的短路保护
- 机动性/电池被驱动器应用
- 电信仪器
- 混合模式/数字式子系统

输入规格  
电压范围: 10%  
Filter: π (Pi) Network  
隔离规格  
额定电压: 1000 Vdc, standard  
5200 Vdc, Max.  
电阻: 1000MΩ, Min  
电容: 60 pF, Typ.  
输出规格:  
波纹和噪声 (at 20 Mhz BW): 75mVp-p, Max.  
短路保护: 连续

线电压变动率: ±0.5%, Max.  
负载电压变动率: ±0.5%, Max.  
温度系数: ±0.02%/°C  
一般规格  
效率: 68~80%  
环境规格  
操作温度 (ambient) -25°C~+71°C  
存储温度: -20°C~+125°C

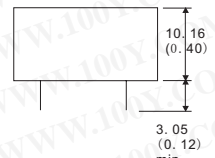
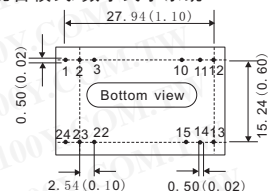
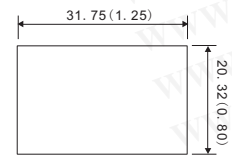

Pin #	STANDARD	3KVdc
1	+V Input	+V Input
2	-V output	+V Input
3	Common	Omitted
10	Common	Common
15	Common	+V Output
22	Common	Omitted
23	-V output	-V Input
24	+V Input	-V Input

Pin #	STANDARD	3KVdc
1	+V Input	+V Input
2	-V output	+V Input
3	Common	Omitted
10	Common	Common
11	+V output	Common
12	-V Input	Omitted
13	-V Input	-V output
14	+V output	Omitted

100Y 编号	厂商编号	制造厂商	说明	DCVout	Current	DCVout	Current	Watts	Efficiency %	DCVin
39766	V5-0512D2	MOTIEN	DC/DC 双组电源转换器(=TRACO_TEM2-0521)	-12V	-83mA	+12V	+83mA	2W	70%	5V
39767	V5-0515D2	MOTIEN	DC/DC 双组电源转换器(=TRACO_TEM2-0522)	-15V	-67mA	+15V	+67mA	2W	70%	5V
39768	V5-1212D2	MOTIEN	DC/DC 双组电源转换器(=TRACO_TEM2-1221)	-12V	-83mA	+12V	+83mA	2W	78%	12V
39769	V5-1215D2	MOTIEN	DC/DC 双组电源转换器(=TRACO_TEM2-1222)	-15V	-67mA	+15V	+67mA	2W	77%	12V
39765	V5-2412D2	MOTIEN	DC/DC 双组电源转换器(=TRACO_TEM2-2412/TEM2-2421)	-12V	-83mA	+12V	+83mA	2W	80%	24V
39770	V5-2415D2	MOTIEN	DC/DC 双组电源转换器(=TRACO_TEM2-2422)	-15V	-67mA	+15V	+67mA	2W	77%	24V



- 1500 Vdc Isolation
- Wide 2:1 输入范围
- 24 Pin DIL 包装
- 调控
- 连续的短路保护
- 镍上漆的铜金属
- MTBF > 1.1 Mhours



输入规格:  
电压范围: 12Vdc, 9-18Vdc,  
24Vdc, 18-36Vdc  
48Vdc, 36-72Vdc  
Filter: π (Pi) Network  
隔离规格  
额定电压: 1500Vdc, standard  
电阻: 1000MΩ, Min

电容: 390 pF, Type  
输出规格:  
电压准确性: ±1%, Max  
环境规格:  
操作温度 (ambient): -40°C~+85°C

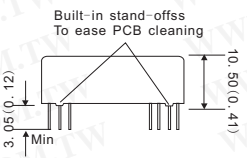
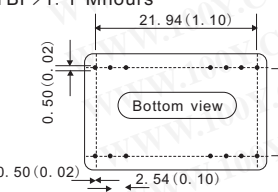
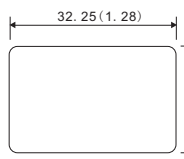

Pin #	STANDARD	3KVdc
1	+V Input	+V Input
2	N. C.	-V output
3	N. C.	Common
9	Omitted	Omitted
10	-V output	Common
11	+V output	+V output
12	-V Input	-V Input
13	-V Input	-V Input

Pin #	STANDARD	3KVdc
14	+V output	+V output
15	-V output	Common
16	Omitted	Omitted
22	N. C.	Common
23	N. C.	-V output
24	+V Input	+V Input

100Y 编号	厂商编号	制造厂商	说明	DCVout	Current	DCVout	Current	Watts	Efficiency %	DCVin
40032	V6-1212D3P	MOTIEN	DC/DC 双组电源转换器(=TRACO_TEL3-1222)	-12V	-125mA	+12V	+125mA	3W	78%	9-18V