

## 绘图型 LCD

详细产品规格 - 请点击 [cn.100y.com.tw](http://cn.100y.com.tw)

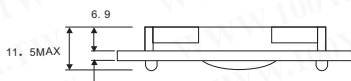

100Y 编号	厂商编号	制造厂商	说明	外宽尺寸	萤幕尺寸	点尺寸
40720	LMG-SS12K64DLYY	SDEC	Led Backlight	98*60mm	CV/272*CV/A339	CD/A266.32*CD/A133.64

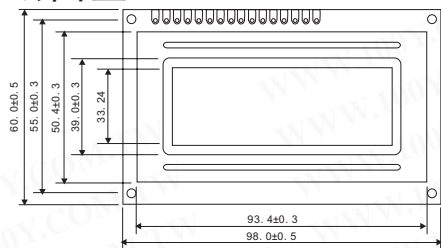

LCD TYPE	STN/FSTN
LCM背后照明型号	EL/FL/LED背后照明
LCM 控制器 IC	修造在LC7981 或等值
LCM电源	DC+5.0V
LED背后照明输入	DC+0.5V
EL背后照明输入	AC 90~100V (400~700HZ)
EL变换器	SDEC-1003A
FL背后照明输入	AC 1KV (30KHZ)
FI变换器	SDEC-FL001 (5A)

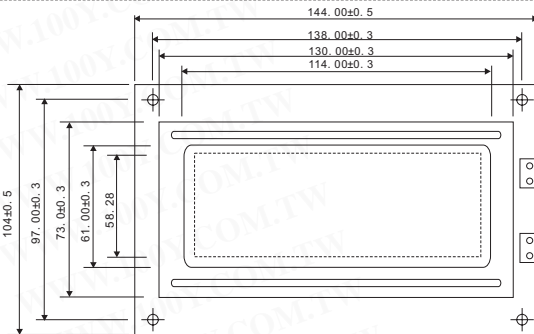

100Y 编号	厂商编号	制造厂商	说明	外宽尺寸	萤幕尺寸	点尺寸
1855	LMG-SS24B12DLYY	SDEC	绘图 LCD 240×128Dots 有背光	144*104*10.5	114*61	0.40*0.40

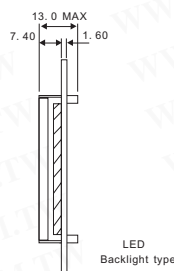
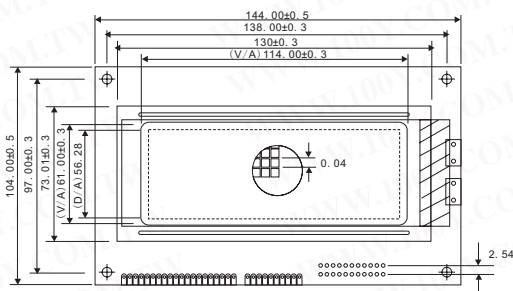

100Y 编号	厂商编号	制造厂商	说明	外宽尺寸	萤幕尺寸	点尺寸
42913	LMG-SS24D12DLNW-E	SDEC	DOT MATRIX LIQUID CRYSTAL DISPLAY	144.0W × 104.0H × 13.0D mm	114.0W × 61.0H mm	0.40W × 0.40H mm

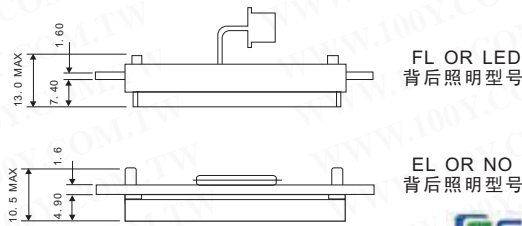
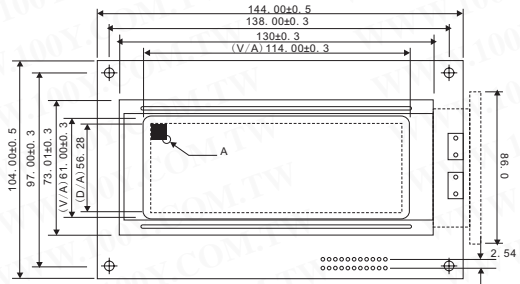
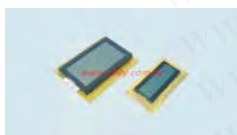

100Y 编号	厂商编号	制造厂商	说明	外宽尺寸	萤幕尺寸	点尺寸
34752	LMG-SS24E12DFNW	SDEC	Graphic Module LCD	15.0W*104.0H*12.5Dmm	114.0W*61.0H mm	240*128DOTS
23222	LMG-SS24E12DLNW-H	SDEC	Graphic Module LCD	15.0W*104.0H*12.5Dmm	114.0W*61.0H mm	240*128DOTS

特点:

LCD TYPE	STN/FSTN
LCM背后照明型号	EL/FL/LED 背后照明
LCM 控制器 IC	修造在LC7981或等值
LCM电源	DC+5.0V
LED背后照明输入	DC+5.0V
EL背后照明输入	AC 90~100V (400~700HZ)
EI变换器	1002A
FL背后照明输入 T	AC 1KV (30KHZ)
FL变换器	FL001 (5A)
LCM直径	180.0x65.0x11.0 (13.0) mm
LCM观察地区	132.0x39.0mm
LCD DOT 大小	0.49x0.49mm
LCD DOT 斜度	0.53x0.53mm

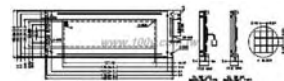

100Y 编号	厂商编号	制造厂商	说明	外宽尺寸	萤幕尺寸	点尺寸
27951	LMG-SS24G64DRY	SDEC	绘图 LCD 240×64 Dots 无背光	180*65*11	132*39	0.49*0.49



服务专线:台湾:886-3-5753170

传 真:台湾:886-3-5753172

E-mail:台湾:sale@100y.com.tw

深圳:86-755-83298787

深圳:86-755-83640655

深圳:100y@163.com

上海:86-21-34970699

上海:86-21-64605107

上海:100y-1@163.com