

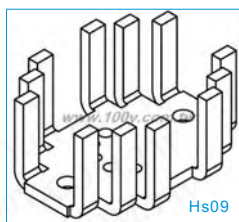

单体式散热片

详细产品规格 - 请点击 cn.100y.com.tw



HS09

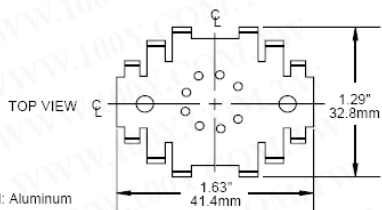

Material: Aluminum
Finish: Black Anodized
Approximate Weight: .36 oz

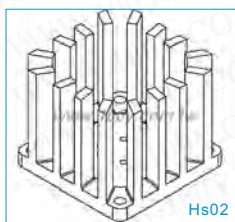
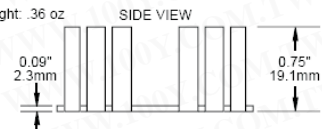

HS02

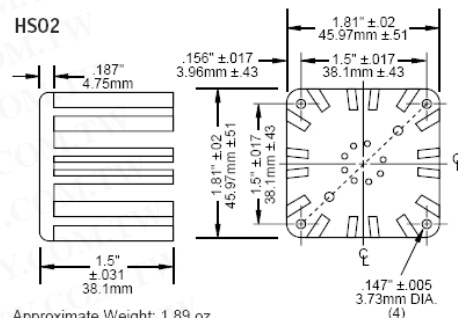

Approximate Weight: 1.89 oz

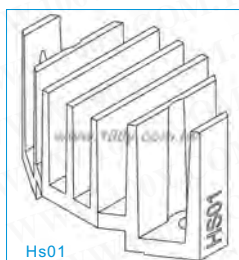

HS01

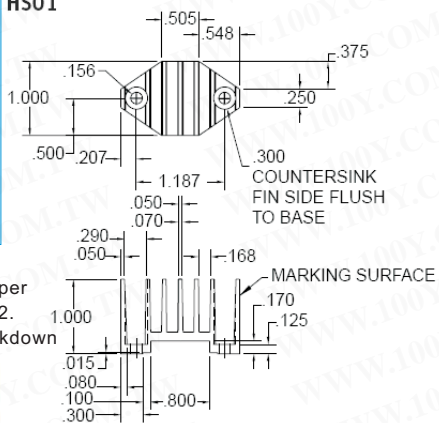

NOTES:
Finish to be black anodize per Mil-A-8625, Type II, Class 2.
For reference, typical breakdown voltage > 300V

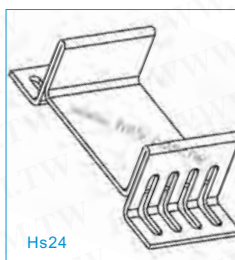

HS24

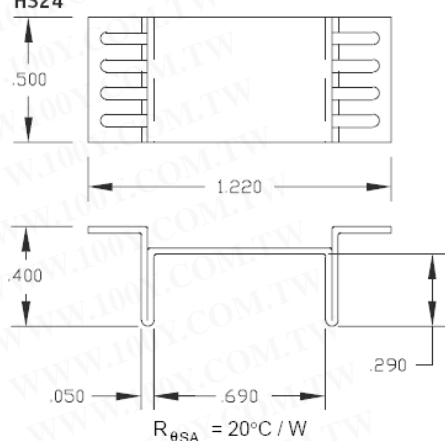

100Y 编号	厂商编号	制造厂商	说明
19963	HS01	APEX	散热片
19964	HS02	APEX	散热片
19968	HS09	APEX	散热片
19998	HS24	APEX	散热片

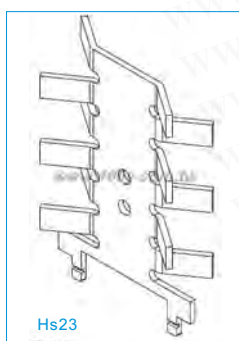

HS23

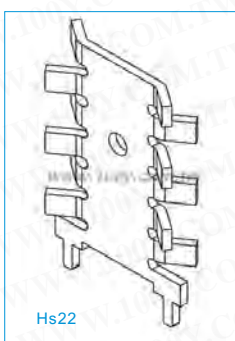
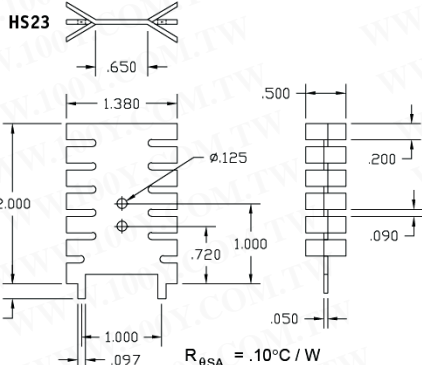

HS22

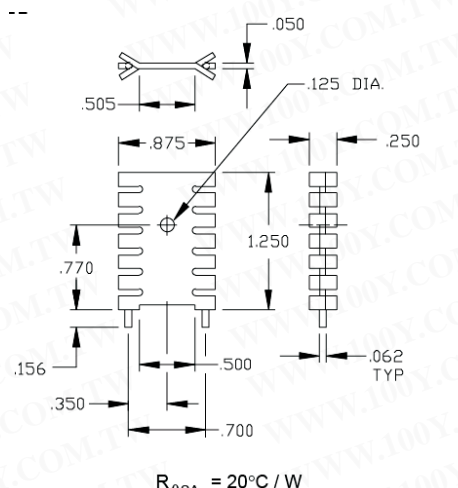

100Y 编号	厂商编号	制造厂商	说明
19996	HS22	APEX	散热片
19997	HS23	APEX	散热片

※每月有上百种新增产品，若您在目录上找不以您需要的元件，请来电或上网查询。
 ※您也可请我们代订商品，欢迎您的来电。

