

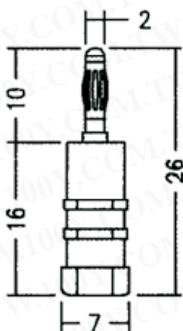

香蕉插头和博士端子 2mm 香蕉插头-镀金



KBG-2-B



说明:

- The 4mm plug are machined from brass with movable multilam contact cage springs.
- Contact surface:Gold / Nickel-plated
- Rated current: 19A 50V



KCG-210-BK

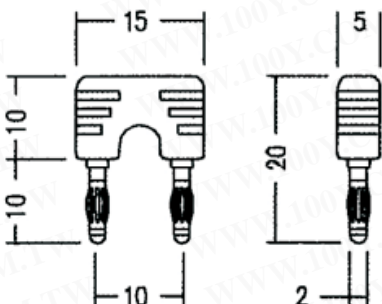

说明:

- The 2mm connecting plug suitable for general interconnection on 2mm socket.
- Contact surface:Gold-plated
- Rated current:10A 50V
- Spacing:10mm
- Color:Black

详细产品规格 - 请点击 cn.100y.com.tw



KAG-2-G

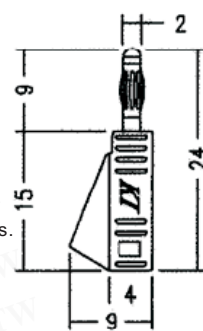

说明:

- The 2mm plug are machined from brass with movable multilam contact cage springs.
- Contact surface:Gold-plated
- Rated current: 10A 50V

100Y 编号	厂商编号	说明	颜色
5226	KAG-2-B	2mm 镀金香蕉接头	黑色
6359	KAG-2-G	2mm 镀金香蕉接头	绿色
5225	KAG-2-R	2mm 镀金香蕉接头	红色
6358	KBG-2-B	2mm 镀金香蕉接头	黑色
1791	KBG-2-G	绿色	2mm 镀金香蕉接头
6303	KBG-2-R	2mm 镀金香蕉接头	红色
12461	KCG-210-BK	2mm 双通香蕉插头	黑-镀金

2mm 博士端子-镀金



KBL-2-B

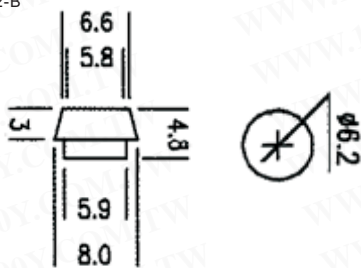

说明:

- BEZEL to suit 2/4 mm socket to provide identification of socket.
- Panel mounting hole 4.5/6.5 mm.



KPG-2-G

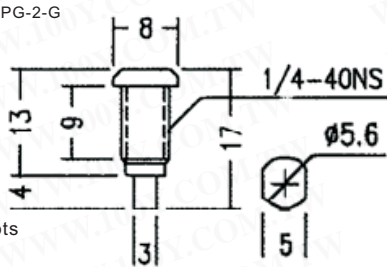

说明:

- 2mm panel-mounting round socket with brass insert accepts a wide range of 2mm plugs.
- Panel mounting hole 6mm.
- Contact surface :Gold -plated.
- Rated current:10A 50V

详细产品规格 - 请点击 cn.100y.com.tw



KSG-2

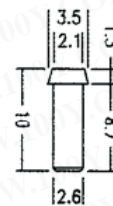

说明:

- 2/4 mm PCB mounting socket.
- Mounting hole 2.8/4.8 mm.
- Contact surface:Gold-plated.
- Rated current: 10/19A 50V



KSG-30A-B

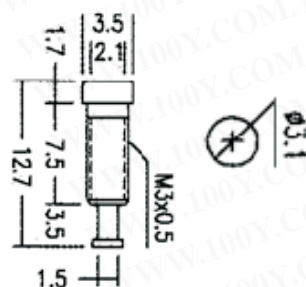

说明:

- A range of 2/4mm socket design to easy mounting and quick assembly.
- Mounting hole 4.5/6.5 mm.
- Contact surfae:Gold/plated.
- Pated current:10/19A 50V

100Y 编号	厂商编号	说明	颜色
3077	KBL-2-B	博士端子色环 2mm	黑色
3079	KBL-2-R	博士端子色环 2mm	红色
3078	KBL-2-Y	博士端子色环 2mm	黄色
2745	KPG-2-B	2mm 博士端子镀金	黑色
3074	KPG-2-G	2mm 博士端子镀金	绿色
3073	KPG-2-R	2mm 博士端子镀金	红色
4789	KSG-2	裸露镀金博士端子 2mm	镀金
3083	KSG-30A-B	博士端子 2mm	黑色
3084	KSG-30A-R	博士端子 2mm	红色
3085	KSG-30A-Y	博士端子 2mm	黄色



更多详细资料请点击 CN.100Y.COM.YW

